

Module 2 Asymmetric Carbon-Carbon Bond Forming Reactions

Lecture 5

2.1 Enantioselective Ene and Cycloaddition Reactions

Alder-ene and Diels-Alder reactions are six electron pericyclic processes between a “diene” or an alkene bearing an allylic hydrogen and an electron-deficient multiple bond to form two bonds σ with migration of the π bond. The lecture covers the examples of recent developments in enantioselective intermolecular Alder-ene glyoxylates with alkenes. Few studies on intra- and intermolecular Diels-Alder type reactions are also covered in the latter part of the lecture.

2.1.1 Carbonyl-Ene Reaction

Chiral Lewis acid catalyzed enantioselective ene reaction is one of the efficient methods for atom economical carbon-carbon bond formation. For example, Ti-BINOL prepared *in situ* catalyzes efficiently the carbonyl-ene reaction of glyoxylate with α -methylstyrene in the presence of molecular sieves with high enantioselectivity (Scheme 1).

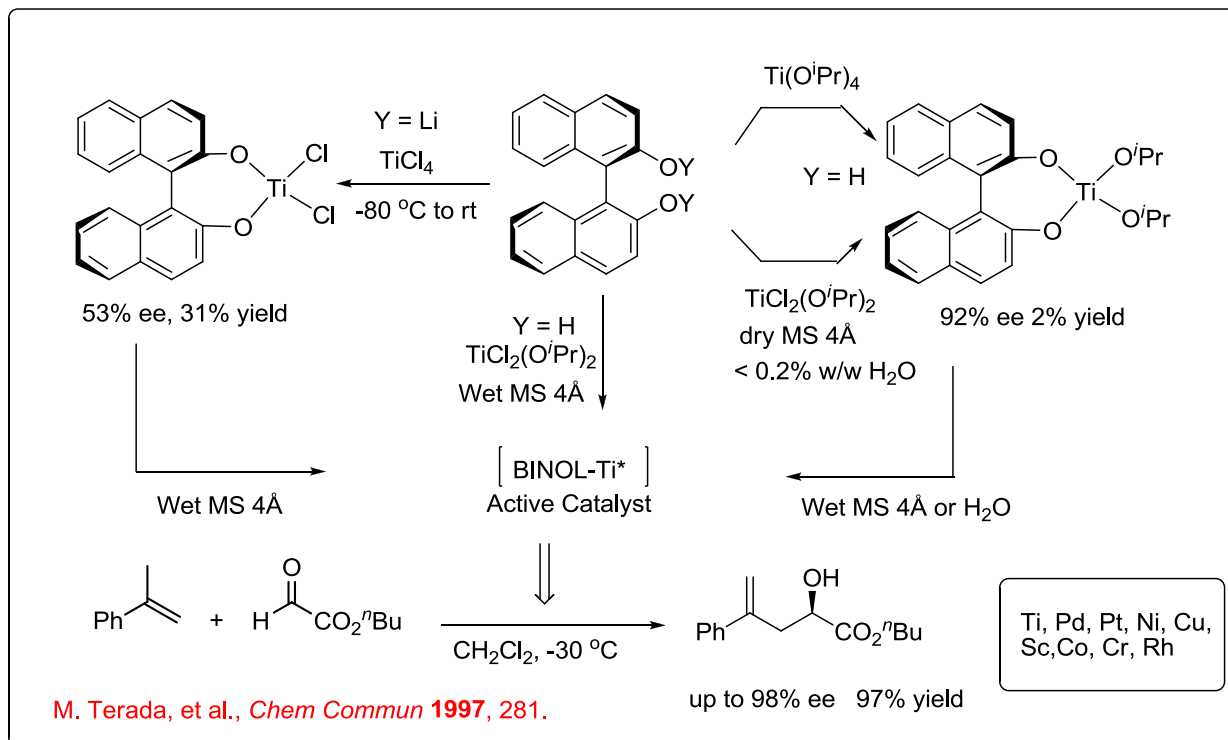

Scheme 1

Besides the early transition metal based Lewis acid catalysts, square planar dicationic late transition metal complexes bearing C_2 -symmetric diphosphine ligands have also been considerably studied as chiral Lewis acids for carbonyl-ene reactions. For example, the isolated MeO-BIPHEP-Pd complex **1a** bearing electron withdrawing benzonitrile as the labile, stabilizing ligands has been used for the ene reaction of ethyl glyoxylate with up to 81% ee (Scheme 2). The isolated **1a** exhibits more catalytic activity compared to that **1b** which is *in situ* generated although both offer similar enantioselectivity.

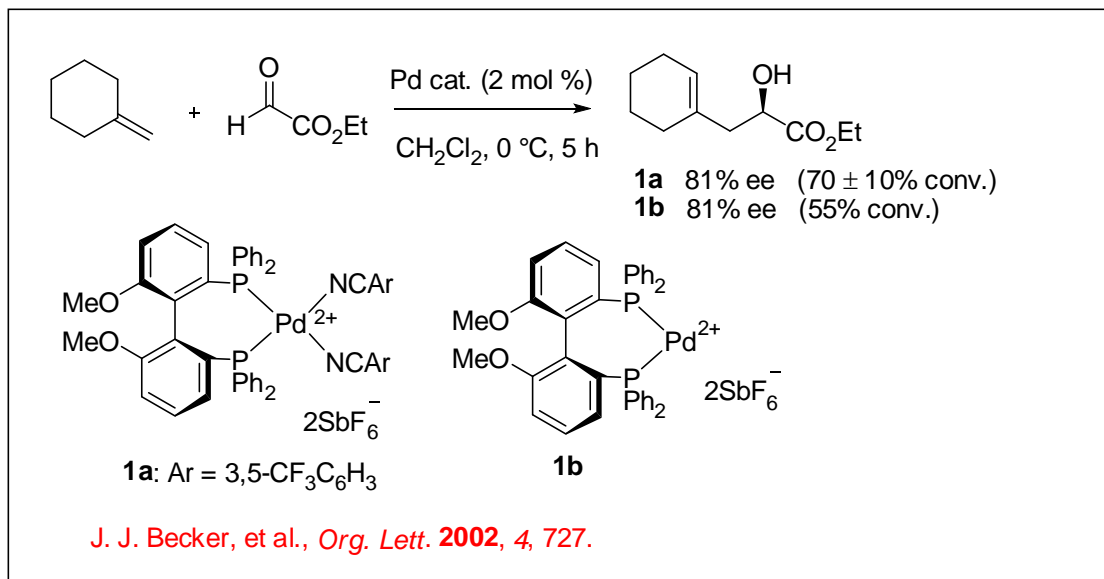

Scheme 2

MeO-BIPHEPs-Pt complexes **3** with OTf⁻ as counter anion also exhibit similar catalytic activity and selectivity in the asymmetric glyoxylate ene reaction (Scheme 3). The addition of phenol facilitates the reaction by trapping the OTf⁻ anion and traces of water.

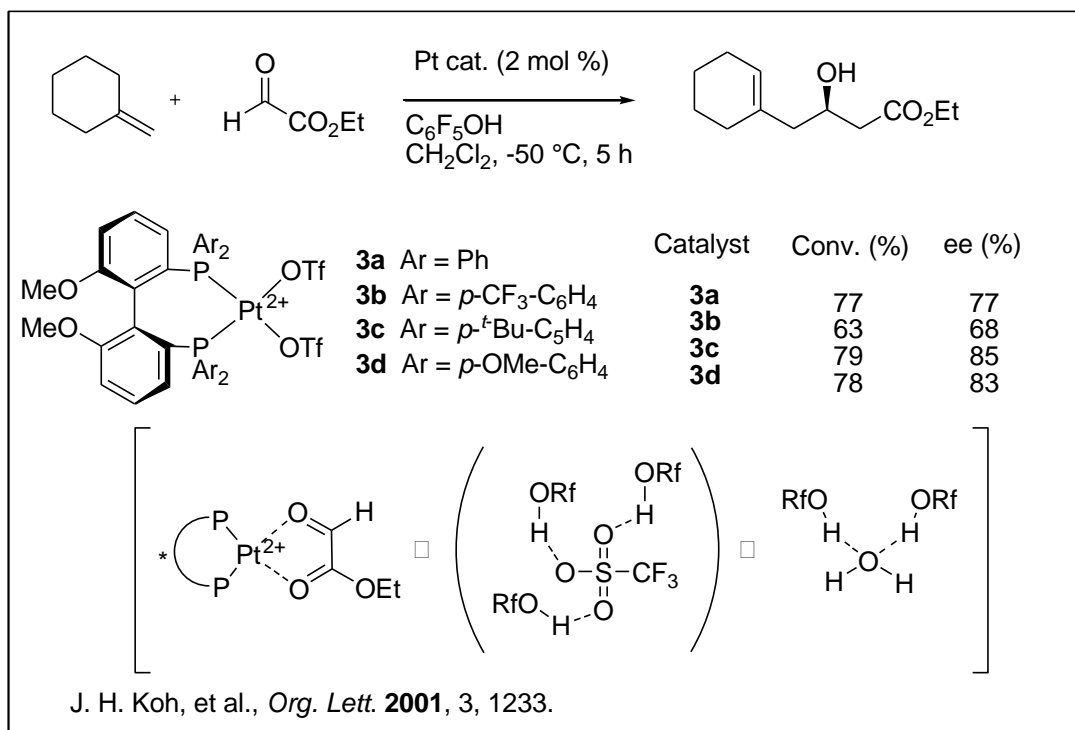

Scheme 3

The glyoxylate ene reaction is also effective using trolox dicationic DPPF-Ni complex **4** with enantioselectivity up to 90% ee (Scheme 4).

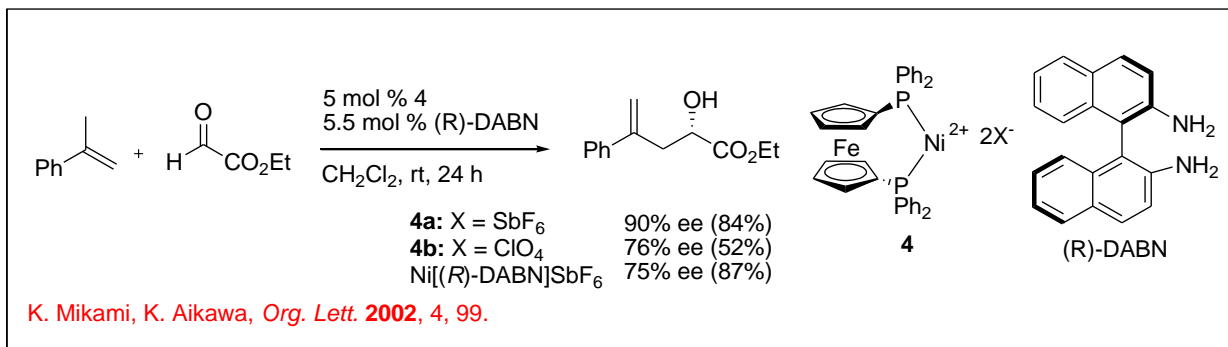

Scheme 4

The glyoxylate-ene reaction can also be carried out using chiral C_2 -symmetric bisoxazolanyl copper(II) complexes **5** and **6** as Lewis acid catalysts (Scheme 5). The aqua complex is air and water stable and exhibits only slight decrease in the reaction rate compared to the anhydrous complex **6**. The sense of asymmetric induction depends on the oxazoline ring substituents, which can be rationalized by the tetrahedral and square-planar intermediates to account for the absolute configuration of the products.

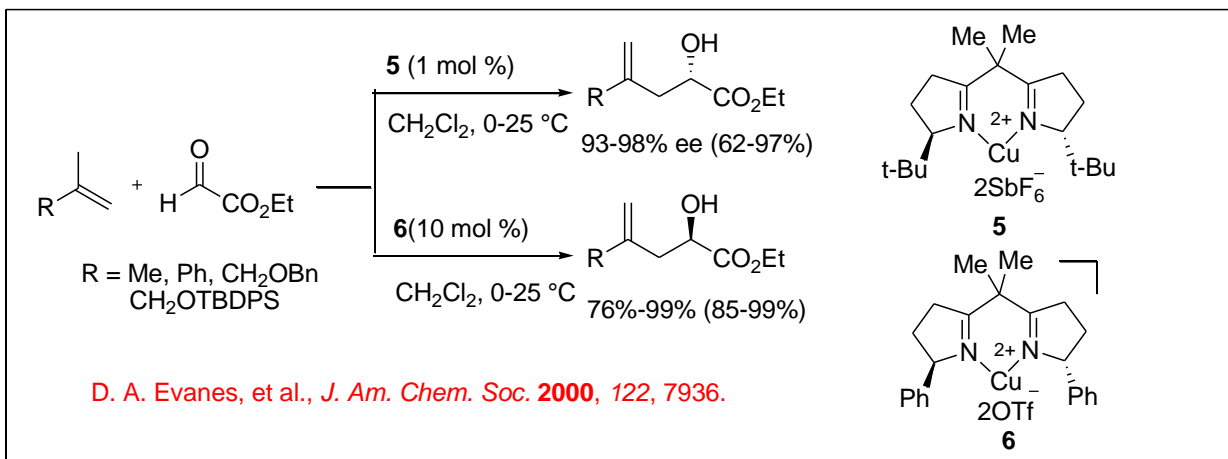

Scheme 5

In addition, chiral C_2 -symmetric trivalent pybox-Sc complex **7** is studied for the carbonyl-ene reactions with *N*-phenyl glyoxamides (Scheme 6). The ene products are obtained with excellent diastereo- and enantioselectivity. Presumably, the products are formed *via* proton transfer from the β -*cis* substituent through an *exo*-transition state.

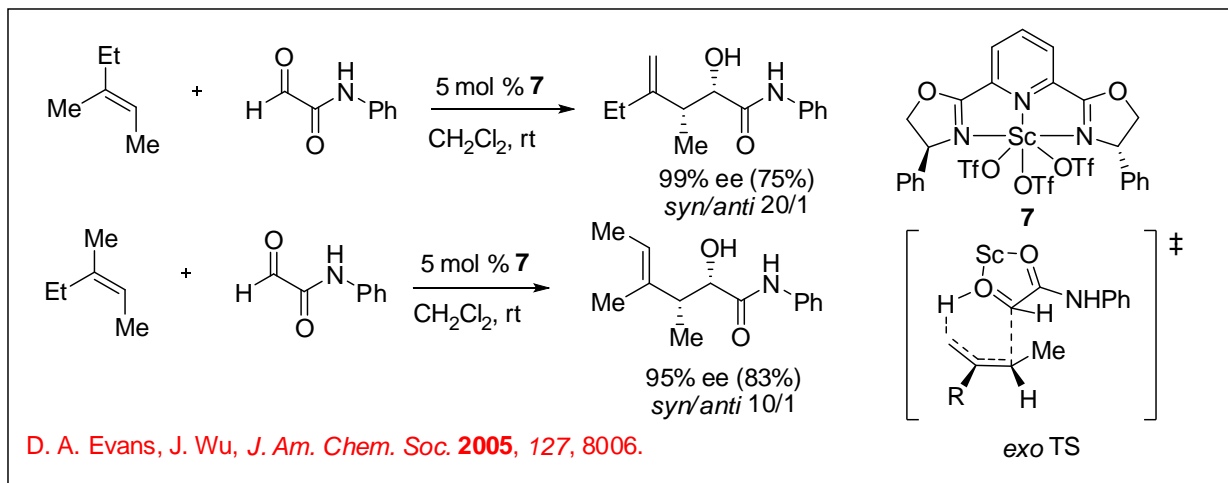

Scheme 6

Co and Cr-based chiral complexes have also been explored for the carbonyl-ene reaction with glyoxylates. For example, chiral β -ketoiminato complex **8** catalyzes efficiently the reaction of 1,1-disubstituted alkene and glyoxyl derivative in high enantioselectivity (Scheme 7). Similar to the earlier described Pd, Pt and Ni-based catalysts, hexafluoroantimonate as a counter anion is found to be the most effective.

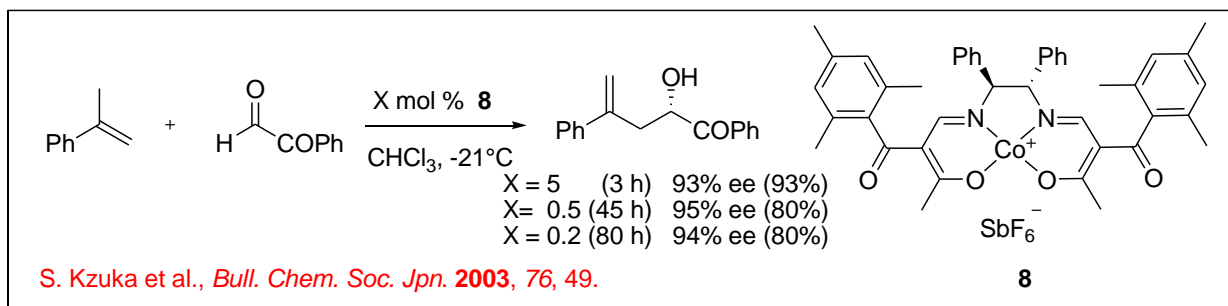

Scheme 7

Chiral Cr(III)-salen complex **9** bearing adamantyl group in the salen ligand has been used for the reaction of ethyl glyoxylate with 1,2-disubstituted alkenes (Scheme 8). The catalyst can be prepared in multigram scale and the ene products are obtained with up to 92% ee. The presence of adamantyl substituent essential for the enhancement in the enantioselectivity

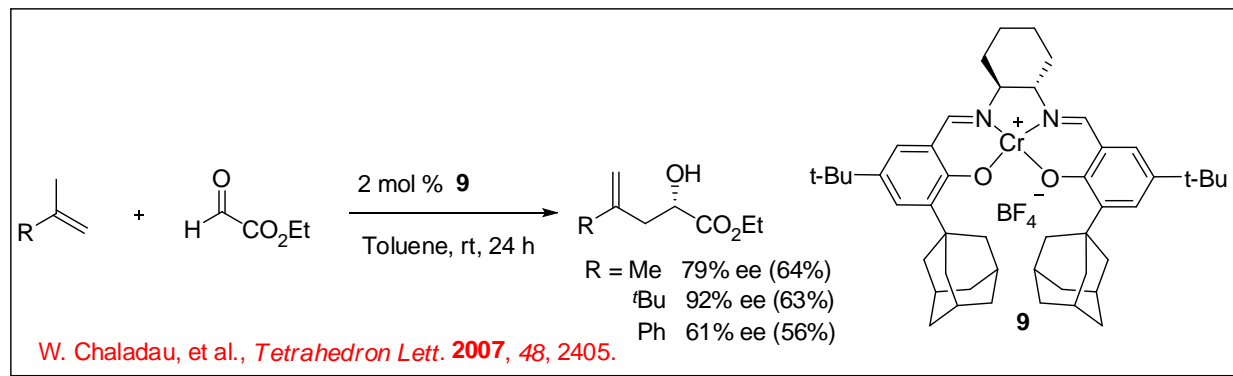

Scheme 8

Besides the metal based catalysts, chiral organocatalysts have also been considerably explored during the recent years for the carbonyl-ene reactions. For example, the chiral phosphoric acid **10** as a chiral Bronsted acid catalyzes readily the enantioselective aza-ene reaction of enamides to imines with excellent enantioselectivity even on a gram scale (Scheme 9).

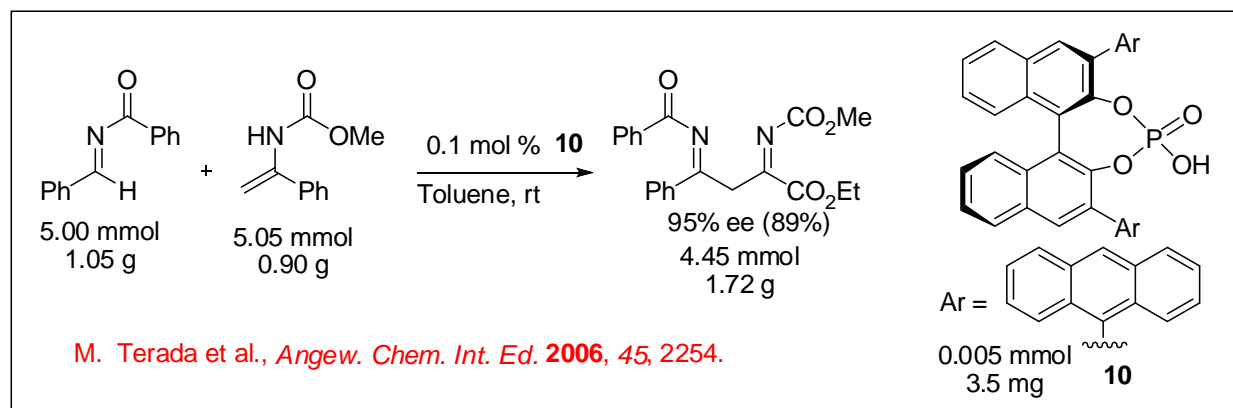

Scheme 9

Besides the intermolecular reactions, intramolecular version of this reaction has also been well explored using chiral metal as well as chiral phosphoric acids as catalysts. For example, the palladium-phosphine complex catalyzed cyclization of 1,7-enynes bearing benzene ring takes place efficiently to afford six membered quinoline derivatives with quaternary stereogenic centers as single enantiomer (Scheme 10).

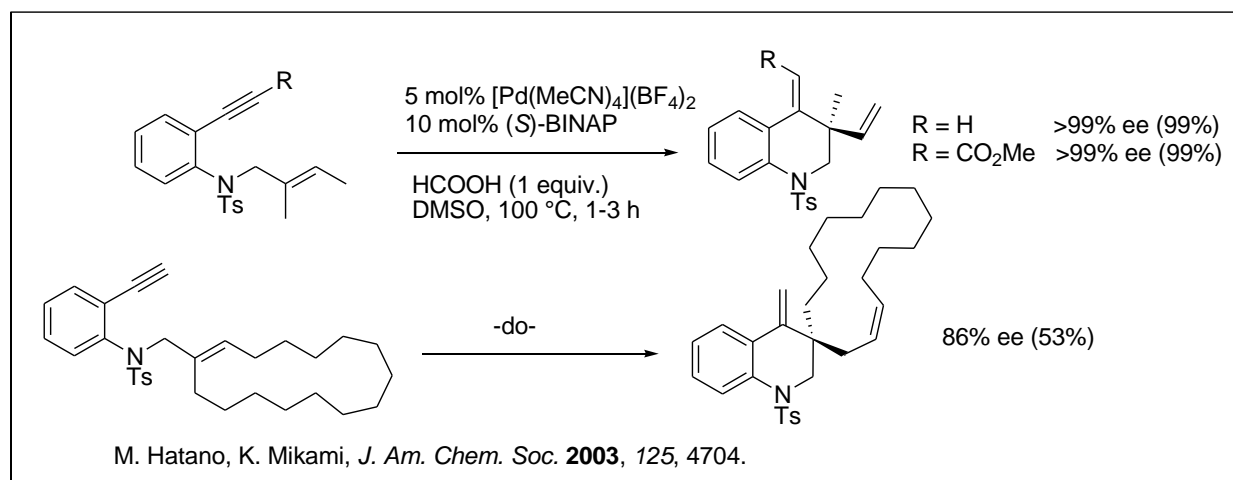

Scheme 10

2.1.2 Diels-Alder Type Reactions

Asymmetric intra- and intermolecular Diels-Alder reactions have made remarkable progress using chiral metal complexes as catalysts. Subsequently, several studies are focused on the use of chiral organocatalysis for this reaction. Since the organocatalysis based reactions are covered in module I, this lecture covers recent examples of the metal catalyzed reactions.

Intramolecular [4+2]-Cycloaddition

Intramolecular Diels-Alder reactions of unactivated dieneynes provide powerful tool to construct 5,6- or 6,6-fused rings. These fused rings can be inducted in the synthesis of many natural products. Therefore, a number of methods using transition metal catalysis have been developed over the past two decades. The chiral Rh complex bearing chiral diene and chiral phosphine has been shown to give better enantioselectivity compared to that bear achiral diene and chiral phosphine complex (Scheme 11).

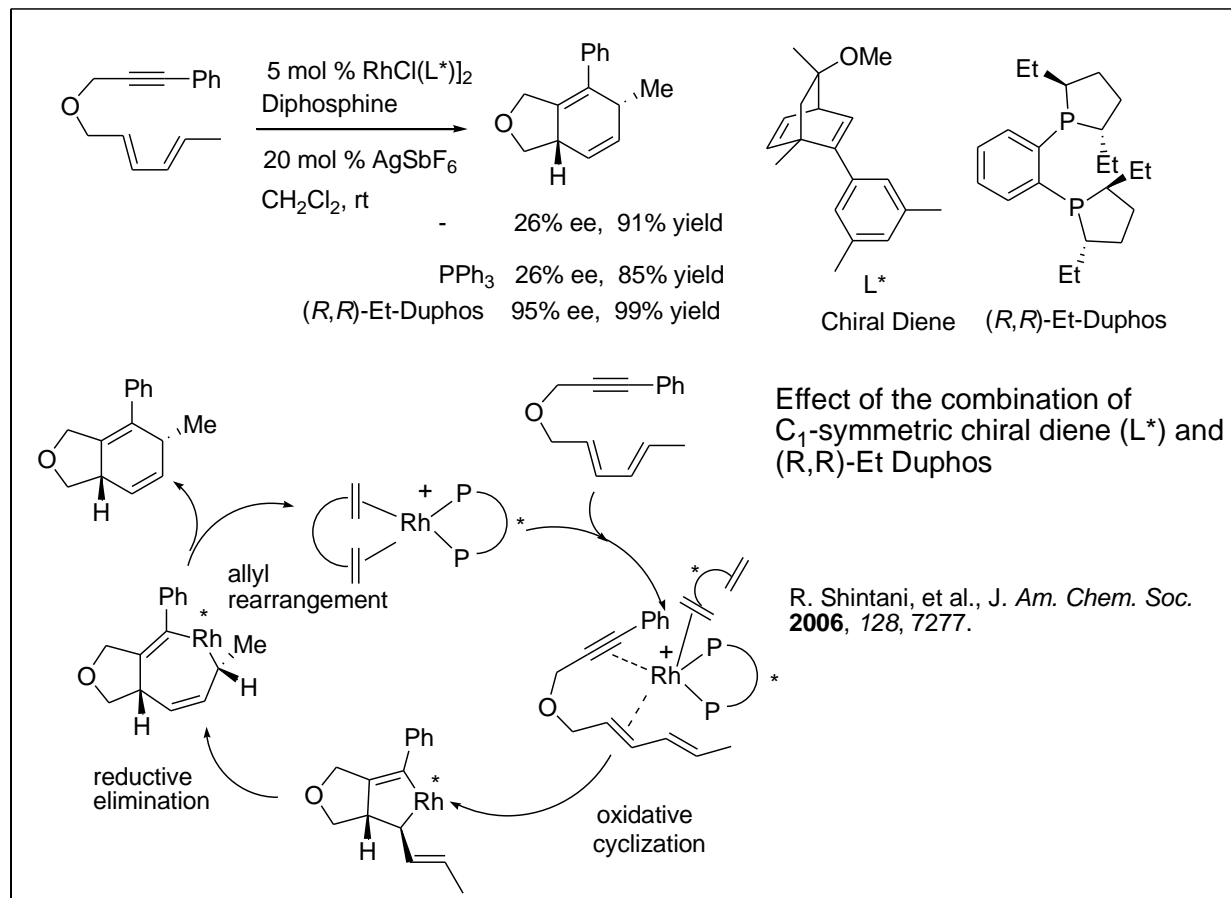

Scheme 11

Intermolecular Diels-Alder Reactions

Intermolecular hetero Diels-Alder reactions have also been extensively explored using both chiral metal complexes as well as chiral organocompounds as catalysts. Since the use of chiral organocatalysis has been covered in module I, this section focuses on few examples using chiral metal complexes as the catalysts. The reaction of benzaldehyde with Danishefsky's diene proceeds in the presence of BINOL/diimine/Zn complex with excellent enantioselectivity and yield (Scheme 12).

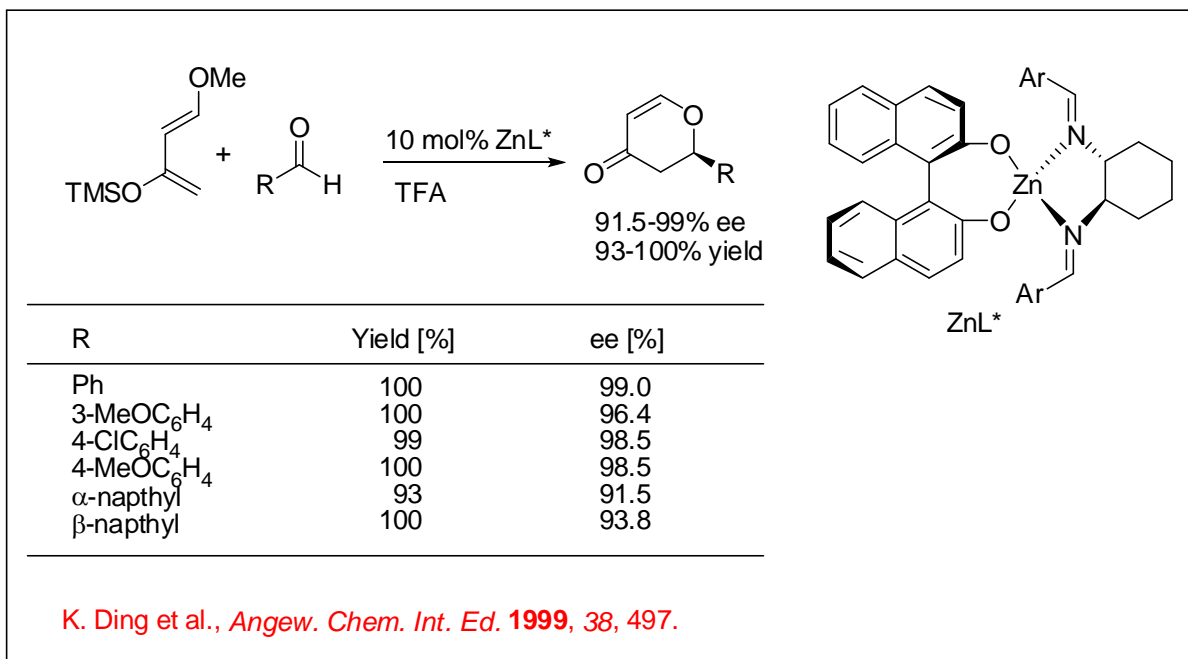

Scheme 12

Chiral box-Cu(II) complexes are found to be excellent catalysts for a variety of hetero Diels-Alder reactions (Scheme 13).

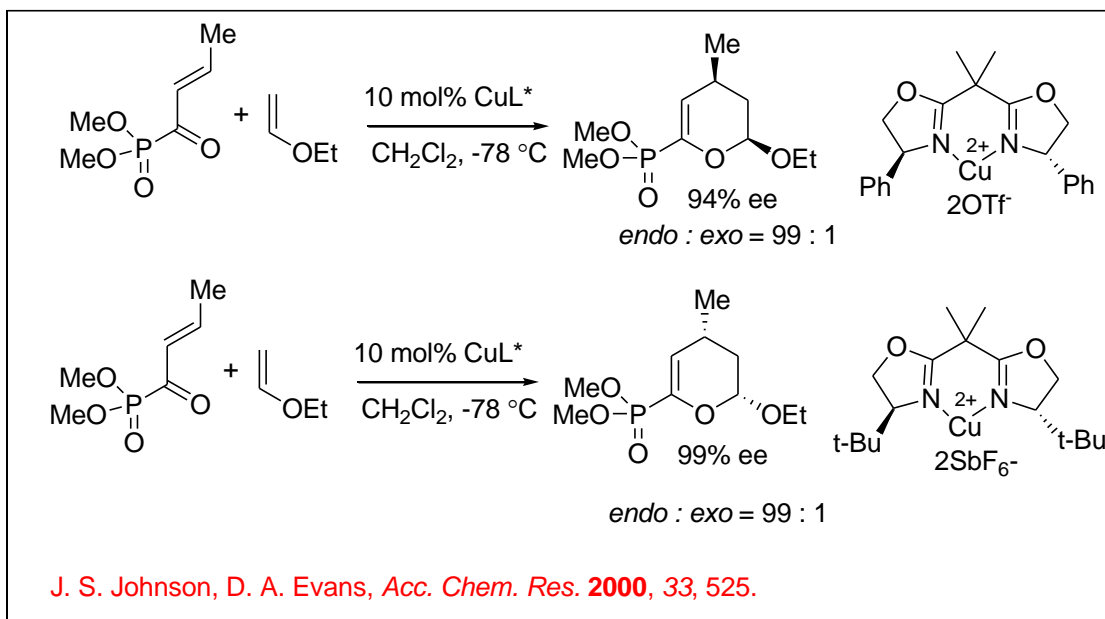

Scheme 13

Reference/Text Book

1. I. Ojima, *Catalytic Asymmetric Synthesis*, 3rd ed., Wiley, New Jersey, 2010.
2. M. B. Smith, *Organic Synthesis*, 2nd edition, McGraw Hill, New Delhi, 2004.

Lecture 6

2.2 *Enantioselective Alkene Metathesis*

Among the alkene metathesis catalysts, Mo and Ru-based complexes have emerged as powerful exhibiting complementary reactivity and functional group tolerance. The asymmetric alkene metathesis provides access to enantiomerically enriched molecules that can not be generally prepared through the commonly practiced strategy. Unlike most of the other enantioselective processes, alkene metathesis, which entails the formation and cleavage of carbon-carbon double bonds, does not involve the direct construction of sp^3 -hybridized stereogenic center. Instead, the stereochemistry is created indirectly, often by desymmetrization of an achiral substrate (Scheme 1), wherein the chiral catalyst has to discriminate between enantiotopic groups or sites of the molecule.

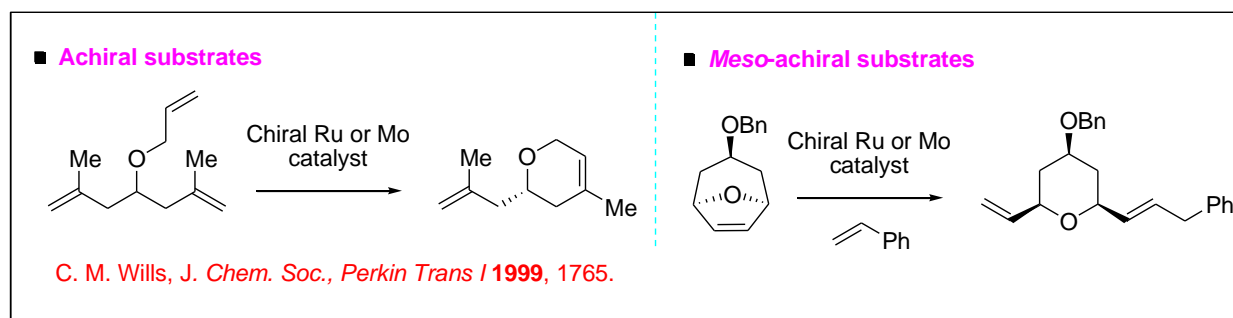

Scheme 1. Desymmetrization in catalytic enantioselective alkene metathesis.

2.2.1 Ring-Closing Metathesis (RCM) Reactions

2.2.1.1 Ru-Catalyzed Reactions

RCM is most commonly used in organic synthesis to construct cyclic systems, which are sometimes difficult to prepare by most of the other methods. During the past decade, several Ru and Mo-based chiral catalysts have been developed for the enantioselective RCM process and made remarkable progress. Scheme 2 summarizes examples for enantioselective RCM employing monodentate chiral

NHC-Ru and chiral Mo-diolate complexes. The Ru-based catalysts are selective compared to Mo-based one, which catalyzes a wide range of substrates.

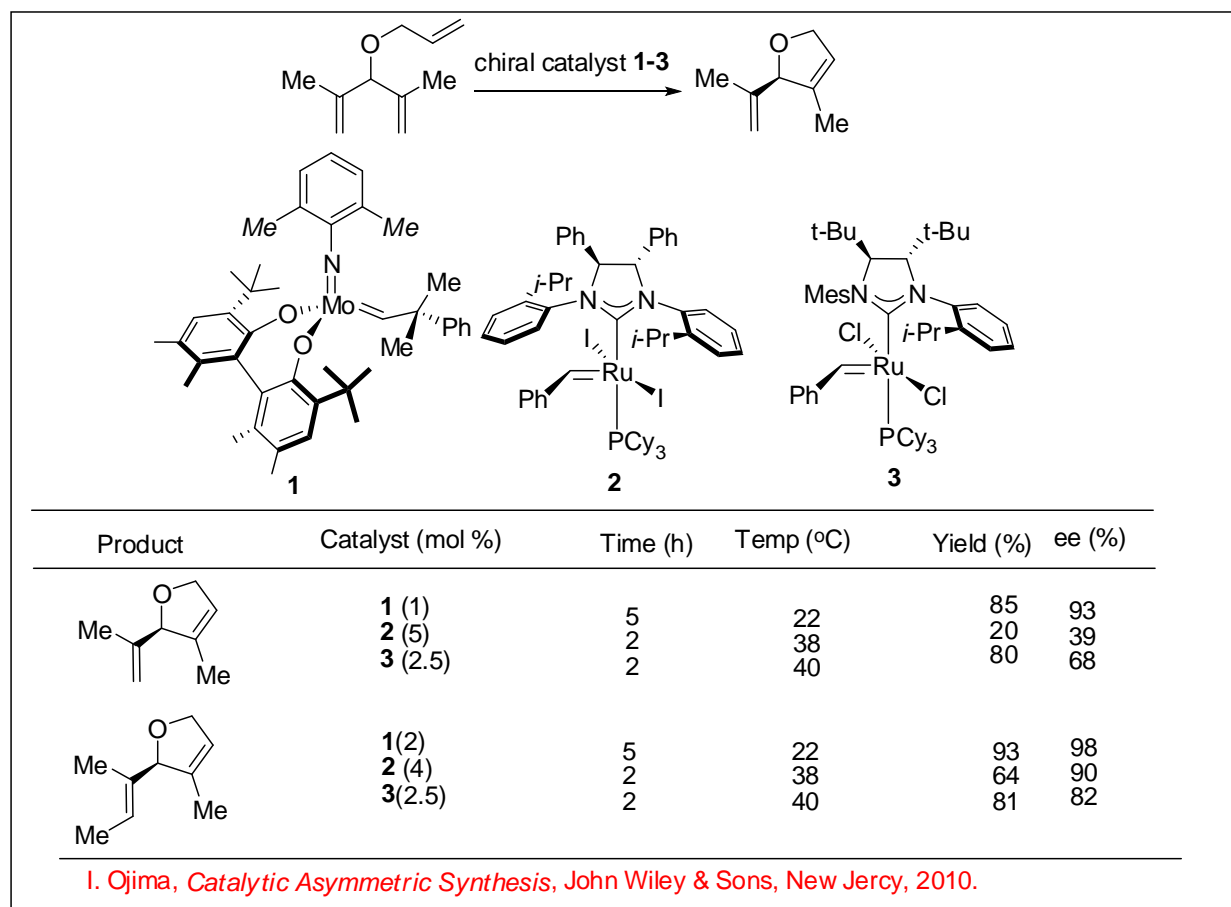

Scheme 2. Comparison of Chiral Mo and Ru Catalysts in Enantioselective RCM

The mechanism of the Ru-catalyzed RCM is outlined in Scheme 3. Initiation of the reaction may take place *via* the dissociation of either the phosphine ligand or chelated etherate moiety. Subsequently, the less substituted alkene may make coordination to the Ru center, which could proceed [2+2]-cycloaddition, followed by cycloreversion and ruthenacyclobutane formation that could lead to the target product. The formation and cleavage of the cyclobutanes are crucial for the enantioselectivity of the products.

2.2.1.2 The Synthesis of Cyclic Enol Ethers using Mo-Catalyzed RCM

Mo-based RCM is found to be successful for the synthesis of furan and pyran products with up to 98% ee (Scheme 4). Although high catalyst loading is required, the products can be constructed with tertiary and quaternary stereogenic centers. In contrast, the Ru-based catalysts are not successful for this transformation

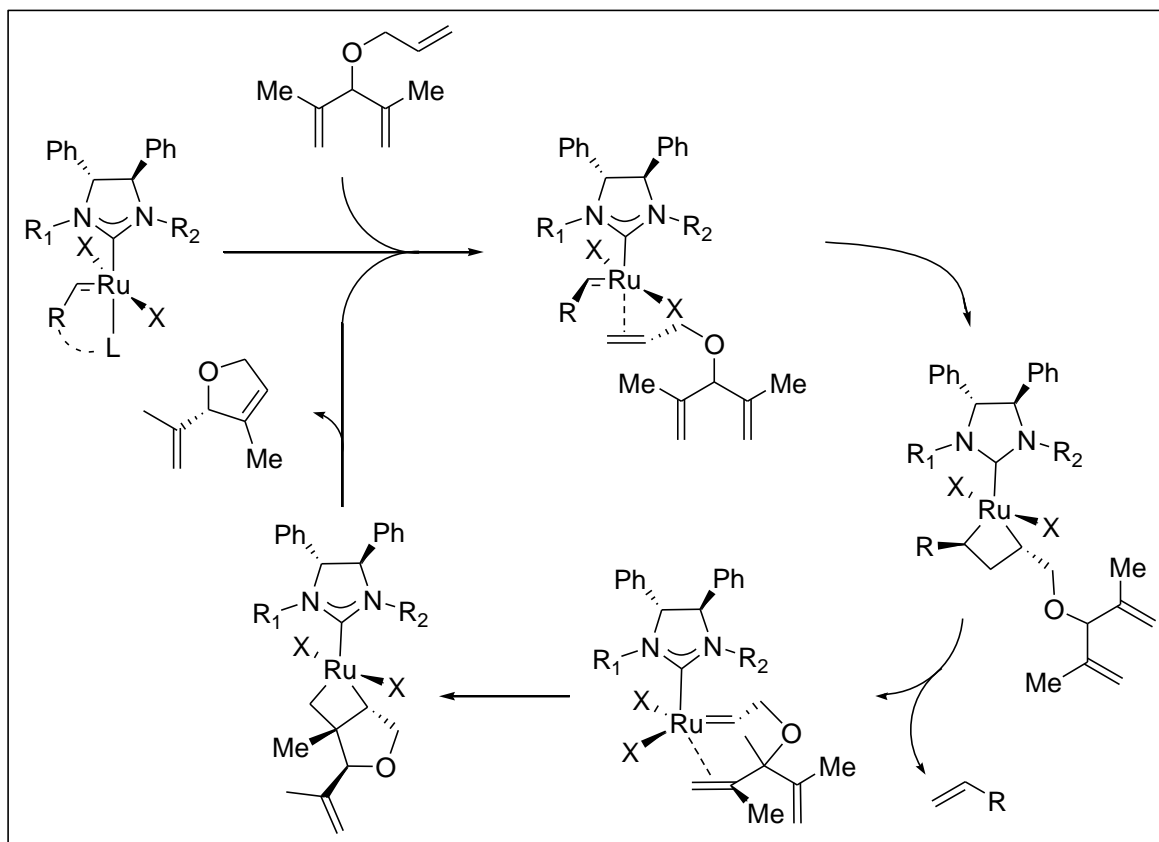

Scheme 3. Mechanism for Ru-catalyzed enantioselective RCM

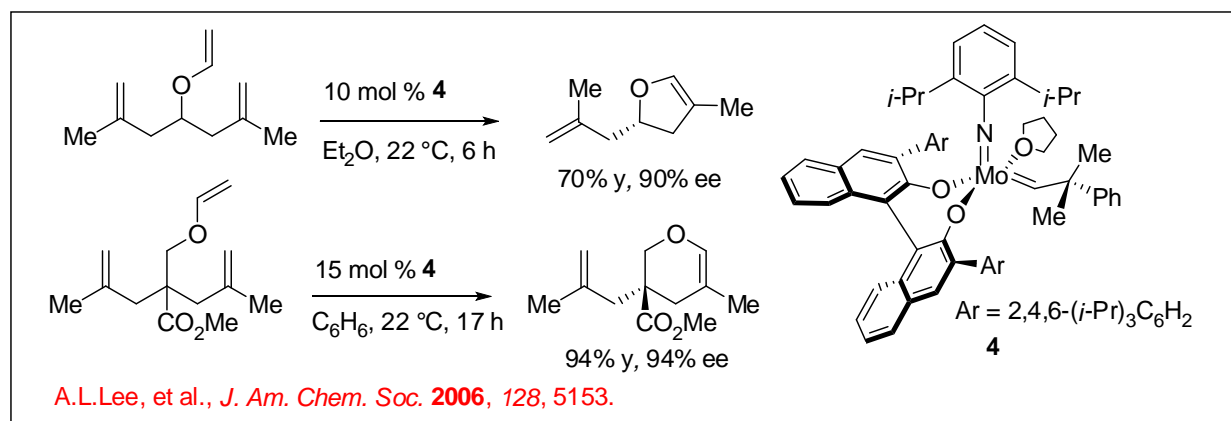

Scheme 4. Synthesis of Cyclic Enol Ethers with Tertiary and Quaternary Stereogenic Centers

2.2.2. Ring-Opening/Ring-Closing Metathesis (RORCM) and Ring-Opening/Cross Metathesis (ROCM)

Following the ring opening, the resulting carbene intermediate can be trapped intramolecularly by a pendant alkene (RORCM, Path A) or intermolecularly using a cross-partner (ROCM, Path B) (Scheme 5). These reaction pathways can be controlled by selection of the appropriate catalyst and cross partner, which can lead to a wide range of enantiomerically enriched products from common starting material. In the absence of intramolecular trap (ROCM process), a number of complex mixture of products can be generated.

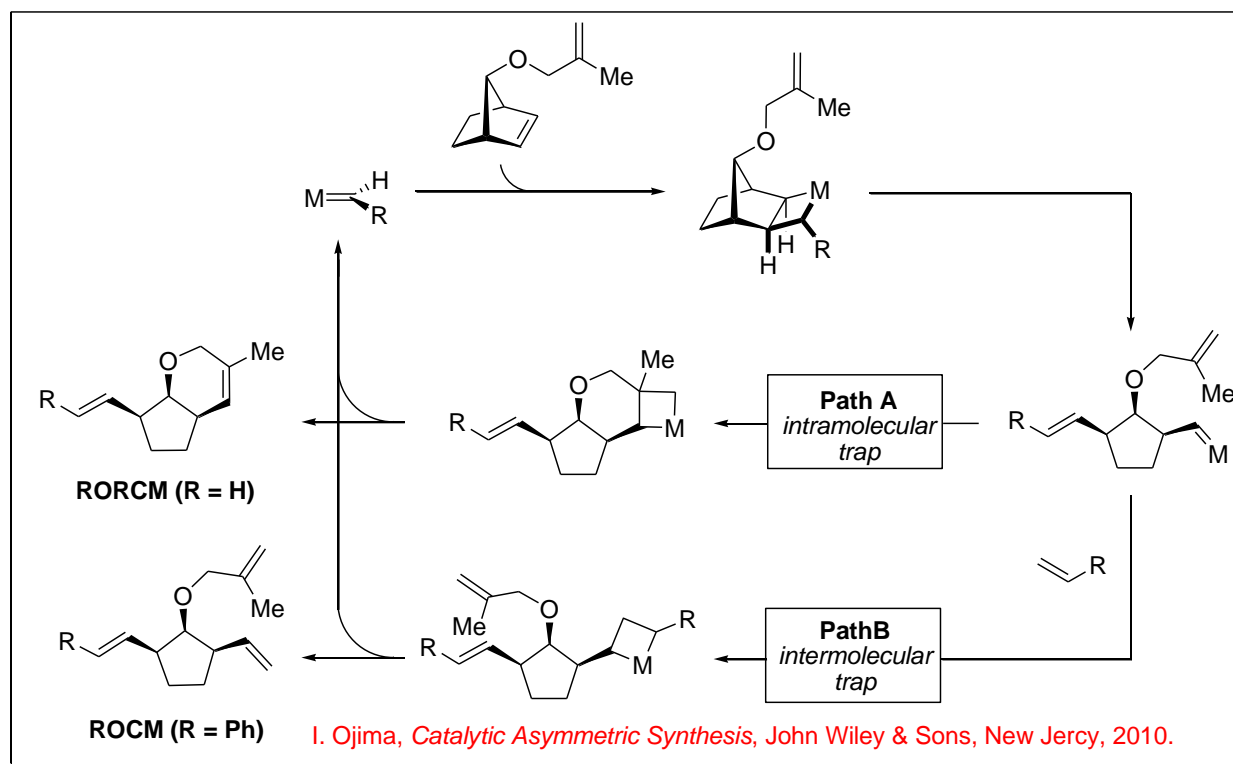

Scheme 5. Pathways for Enantioselective RORCM versus ROCM Products

Scheme 6 presents examples for the Mo and Ru-catalyzed enantioselective ROCM processes. Norbornenes react with styrene *via* ROCM with high enantioselectivities. In both cases, *E*-alkenes are generated. In the absence of styrene, in the case of Mo-based system, RORCM product is formed with 92% ee. The substrate used for the Ru-catalyzed ROCM process, proceed polymerization in the presence of Mo-catalyst instead of ROCM process.

Scheme 7 shows the comparison of the Ru-catalyzed ROCM of norbornenes. The catalysts **7** and **8** bearing monodentate NHC ligands exhibit greater reactivity (i.e., lower catalyst loading) compared to the complex bearing bidentate NHC ligand **6**. But the systems using **7** and **8** produce poor *E/Z* selectivity, whereas the reaction using **6** gives exclusively *E*-isomer.

The synthesis of isoindole has been recently shown using chiral Ru-catalyzed RORCM with moderate enantioselectivity (Scheme 8). In this reaction the use of ethylene is to facilitate the release of the catalyst. The direct alkene metathesis product is unstable and thus it was isolated after hydrogenation.

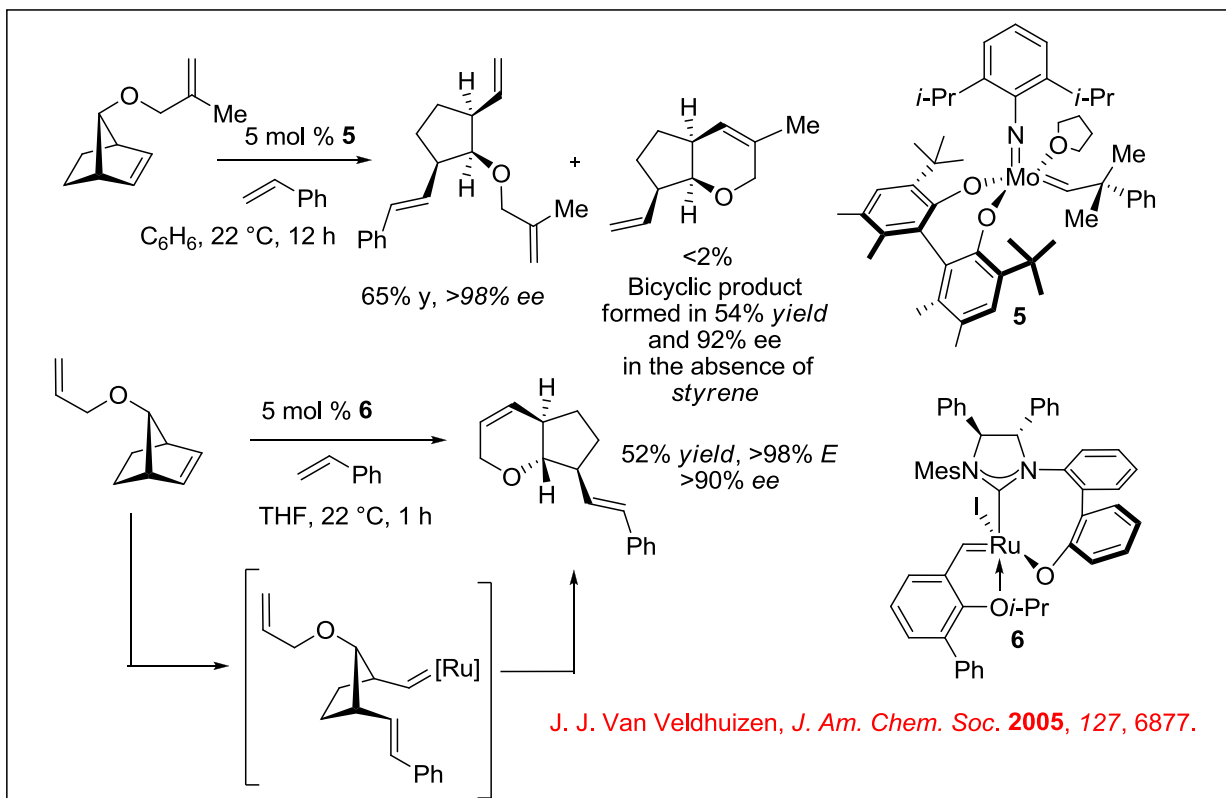

Scheme 6. Mo- and Ru-Catalyzed Enantioselective ROCM of Norbornenes.

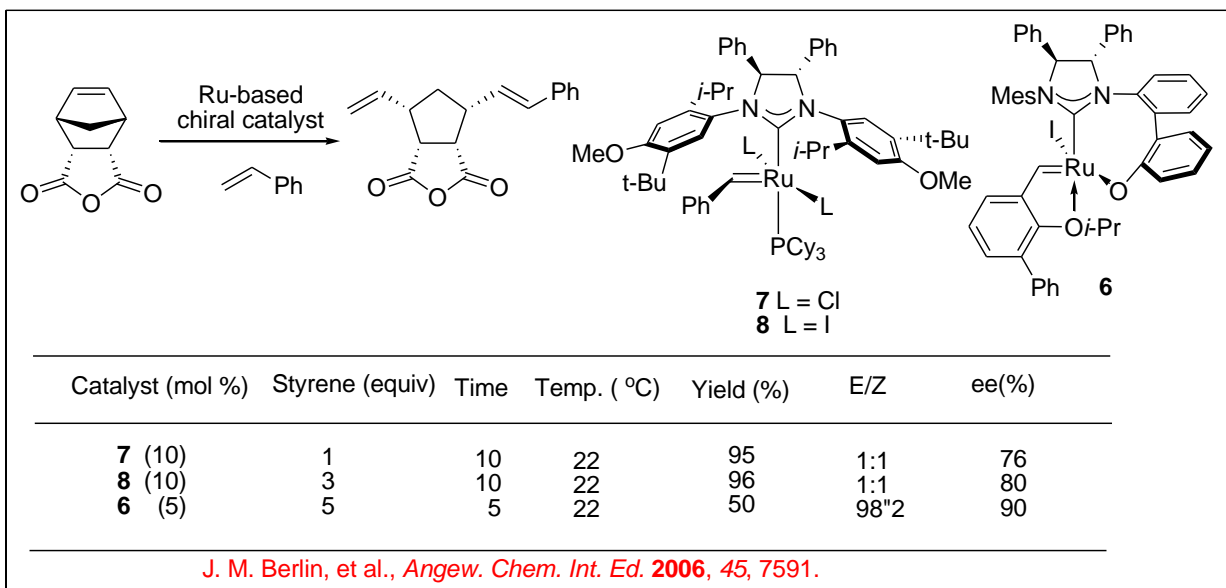

Scheme 7. Comparison of the Activity of Chiral Ru Catalysts in ROCM of Norbornene

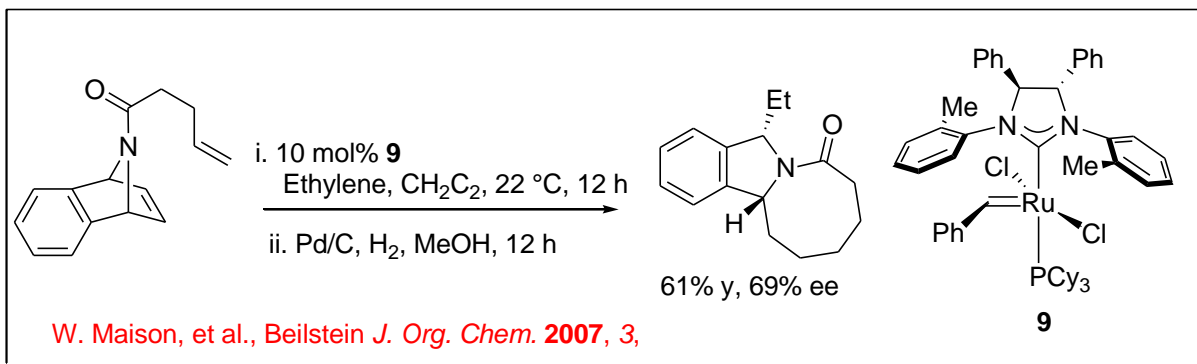

Scheme 8

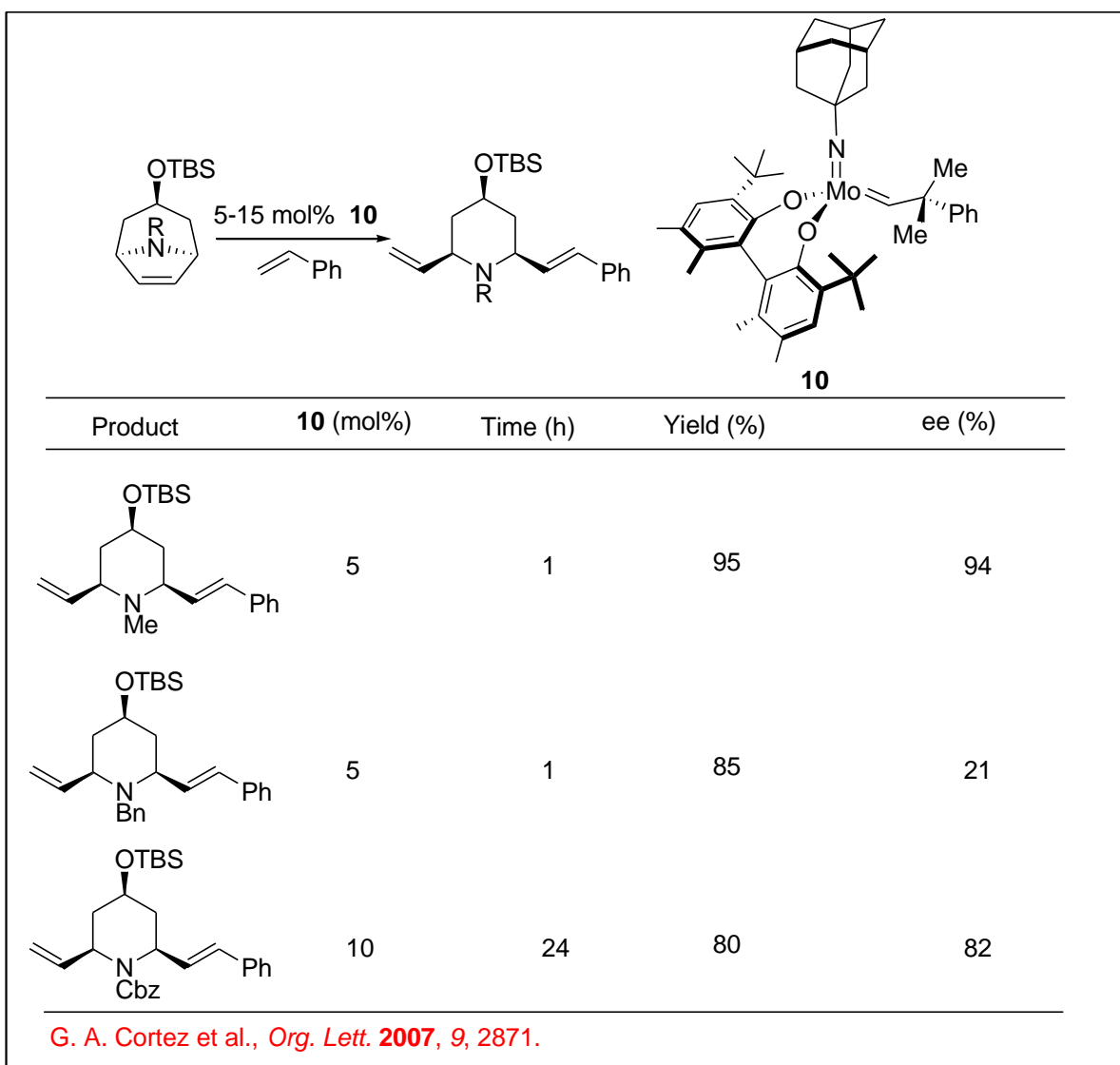
 Scheme 9. Enantioselective ROCM Reaction of *meso*-Azabicycles

2,6-Disubstituted piperidines are important structural unit present in medicinally significant compounds. Using the Mo-based enantioselective ROCM reactions, the synthesis of the *N*-protected 2,6-substituted piperidines can be accomplished from of *meso*-azabicycles with moderate to high enantioselectivities (Scheme 9).

Cross-Metathesis (CM)

Catalytic enantioselective CM is least developed in enantioselective alkene metathesis reactions. Unlike the ring-closing and ring-opening metatheses that are thermodynamically driven, there is minimal driving force for the CM. In addition, selectivity between two different cross partners leads to complex. Scheme 10 presents some examples of CM using chiral Ru complexes with moderate enantioselectivity. These substrates don't proceed RCM due to ring strain of the products.

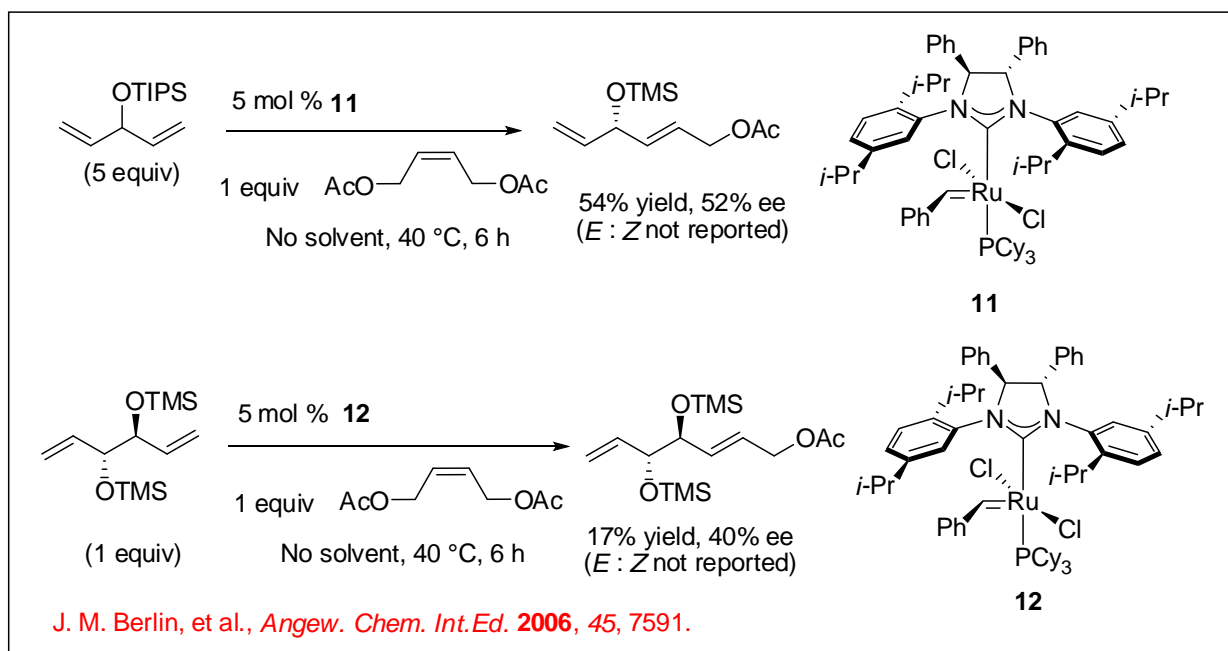

Scheme 10. Catalytic enantioselective cross-metathesis reactions

Problems

How will you synthesis the following compounds using alkene metathesis?

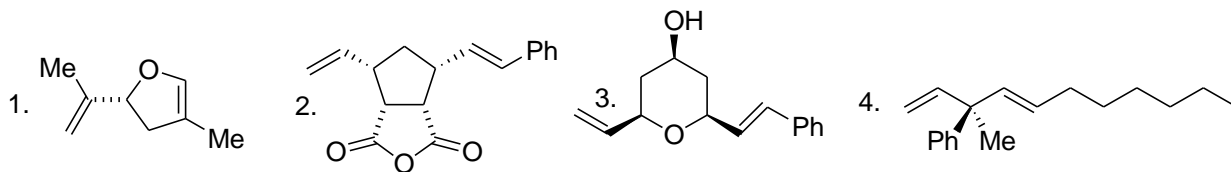

Reference/Text Book

3. I. Ojima, *Catalytic Asymmetric Synthesis*, 3rd ed., Wiley, New Jersey, 2010.
4. M. B. Smith, *Organic Synthesis*, 2nd edition, McGraw Hill, New Delhi, 2004.

Lecture 7

2.3 Carbometallation and Carbocyclization Reactions

Organometallic compounds add to carbon-carbon multiple bonds to give a new organometallic species, which could be further modified to yield new carbon-carbon bonds. These processes are called as “carbometallation reactions”. It primarily refers to the relationship between the reactants and products (Scheme 1). This lecture covers some examples of the asymmetric carbometallation reactions using Rh, Cu and Pd-based systems.

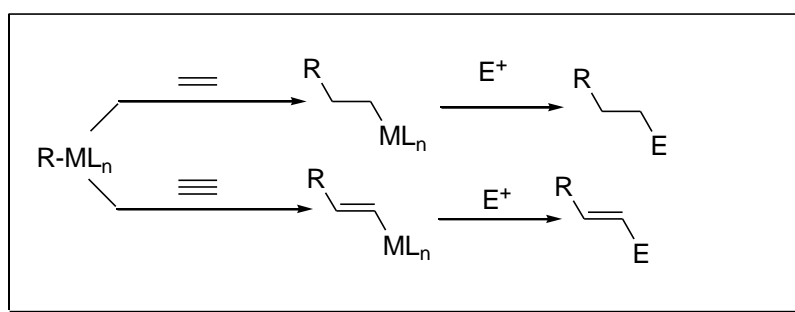

Scheme 1

2.3.1 Rhodium-Catalyzed Reactions

Hydrogen-mediated carbon-carbon bond formation has emerged as powerful industrial process in chemical industries. For example, the hydroformylation and Fischer-Tropsch reactions are well known for the hydrogen-mediated carbon-carbon bond formation reactions. These processes require heterolytic activation of molecular hydrogen to give monohydride species, where the C-H reductive elimination pathway is disabled. Addition of a metal hydride to carbon-carbon multiples bonds (i.e., alkene and alkyne) give organometallic species that could be rapidly captured by an electrophile (i.e., aldehydes and imine) prior to its reaction with molecular hydrogen *via* oxidative addition or σ -bond metathesis of carbon-metal bond. Scheme 2 illustrates metal-dihydride route (leading to hydrogenation) and metal-monohydride route (leading to C-C bond formation) with an alkyne.

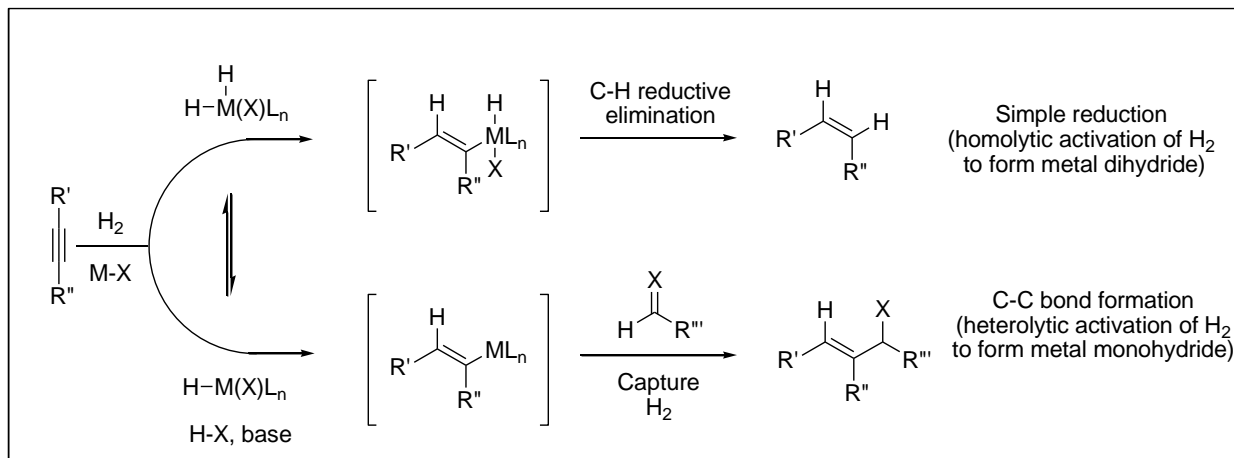

Formation of the monohydride organometallic species depends on the choice of the catalytic system. For example, the heterolytic activation of molecular hydrogen is observed with cationic rhodium complexes in the presence of base. The reaction takes place *via* the oxidative addition of the molecular hydrogen with metal species followed by a base induced reductive elimination of HX (Scheme 3).

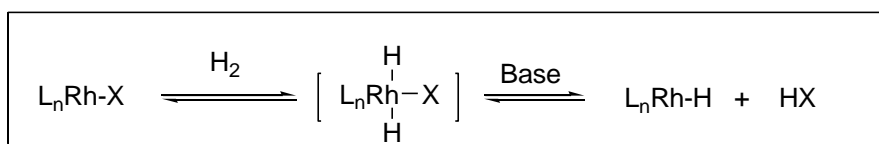

For example, Scheme 4 presents enantioselective reductive cyclization of 1,6-enynes using $\text{Rh}(\text{COD})_2\text{OTf}$ and (*R*)-BINAP in the presence of molecular hydrogen. This carbocyclization reaction is compatible with various functional groups, however, the yield and enantioselectivity of the product depends on the structure of 1,6-enynes and the ligands.

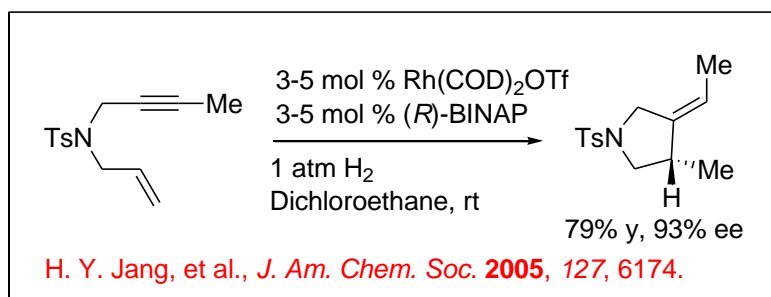

A possible mechanism has been proposed for this reaction based on deuterium labeling control experiments (Scheme 5). The catalytic cycle starts with cycloaddition of $Rh^I L_n$ and 1,6-enyne forming rhodacyclopentene. Homolytic hydrogen activation *via* oxidative addition of molecular hydrogen or σ -bond metathesis may lead to the formation of vinyl-rhodium vinyl species that could afford cyclization product by reductive elimination to complete the catalytic cycle.

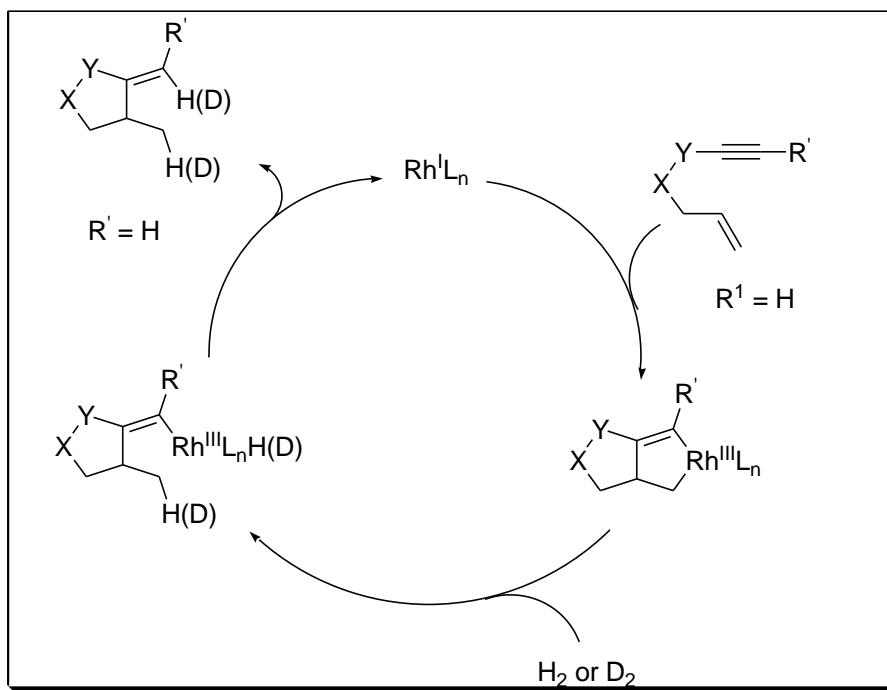

Scheme 5

1,4-Conjugate addition of organometallic reagents to α,β -unsaturated carbonyl compounds afford effective method for carbon-carbon bond formation. Much effort has been on the development of asymmetric version of the reaction using a series of catalytic systems. The first reductive aldol cyclization of keto-enone with phenylboronic acid has been shown utilizing $\text{Rh}[(\text{COD})\text{Cl}]_2$ and (*R*)-BINAP with yield and enantioselectivity (Scheme 6).

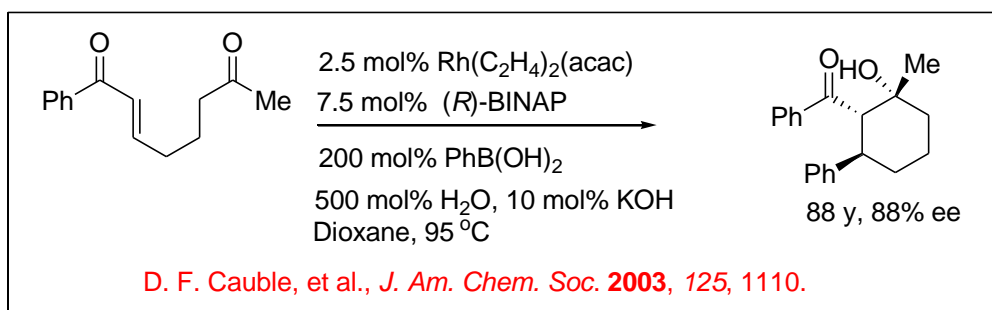

Scheme 6

The mechanism of the reaction is presented in Scheme 7. The observed stereochemistry has been rationalized by assuming *Z*-enolate formation.

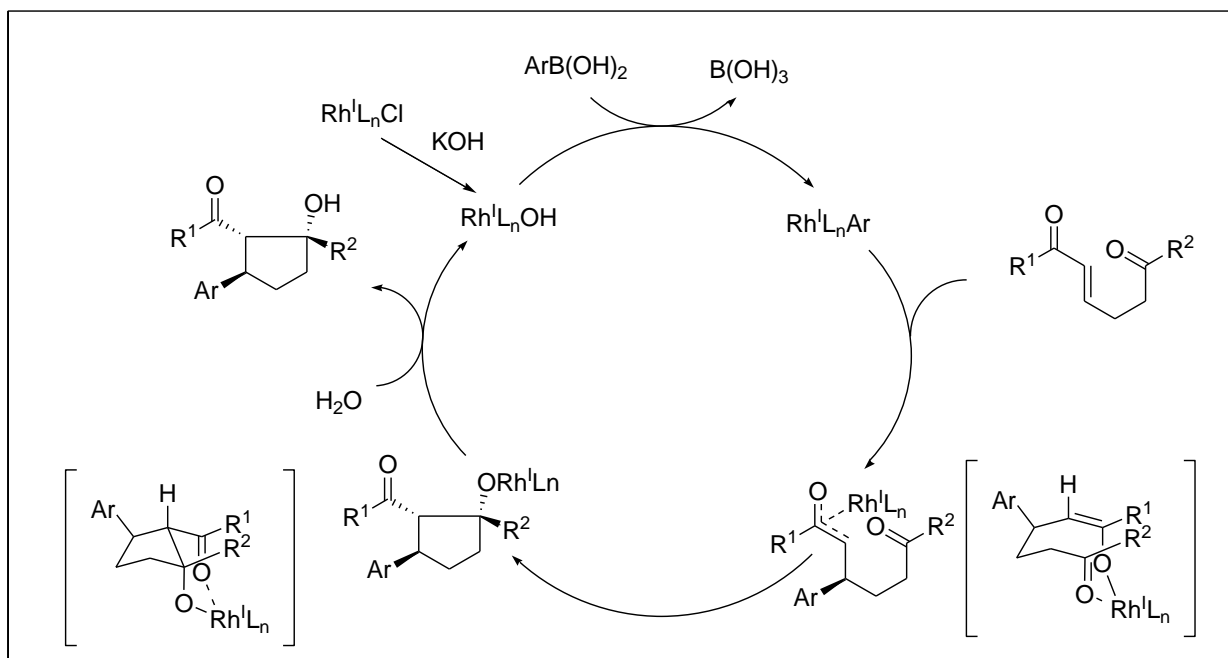

Scheme 7

2.3.2 Copper-Catalyzed Reactions

CuH is found to be highly efficient catalyst for the asymmetric reductive aldol cyclization of keto-enones to give the target product as a singly diastereoisomer with high enantiopurity (Scheme 8). These reactions use ferrocenylphosphines, (*S,R*)-PPE-P(*t*-Bu)₂, as effective chiral ligands in the presence of silane as a hydride source (Scheme 8). These reactions can also be carried out under heterogeneous as well as aqueous conditions with surfactant.

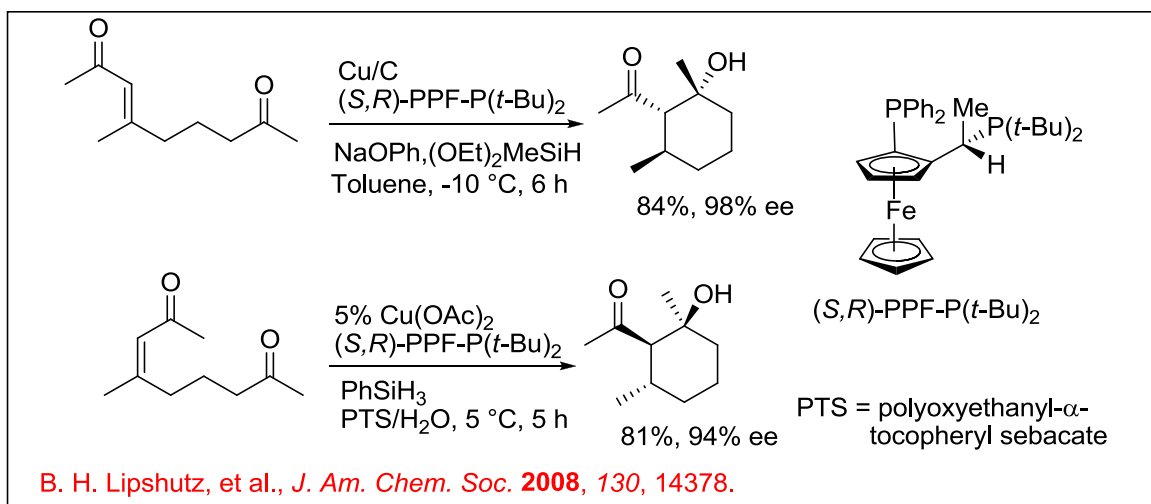

Scheme 8

2.3.3 Palladium-Catalyzed Reactions

The palladium-catalyzed cross-coupling reactions of aryl or alkenyl halides with alkenes in the presence of base are among the powerful reactions in organic synthesis to construct carbon-carbon bonds. The asymmetric version of the reaction is also well explored. Scheme 9-12 illustrates some examples for the intramolecular and intermolecular Heck reactions. In 1970, the Heck reaction was discovered and, in 1989, the first example of asymmetric intramolecular Heck reactions appeared using Pd(OAc)₂ with (*R*)-BINAP with moderate enantioselectivity (Scheme 9).

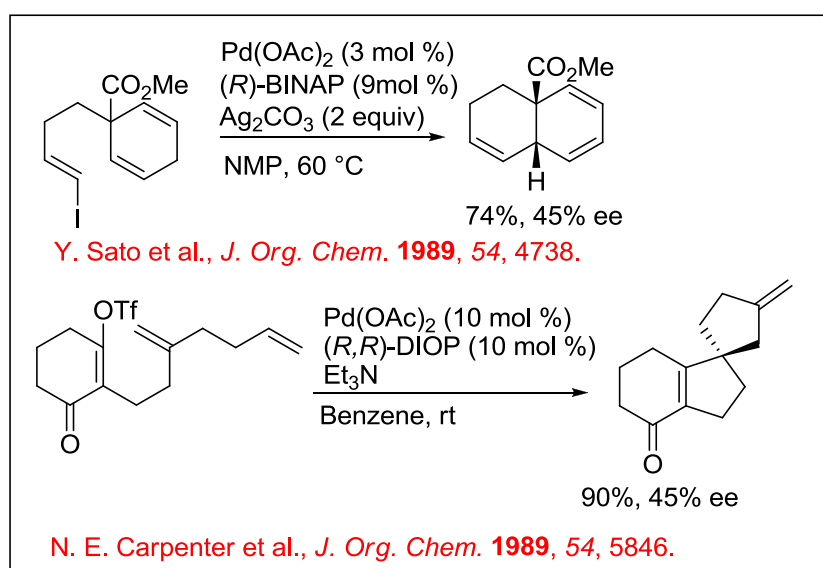

Scheme 9

The intramolecular Heck reaction finds wide applications in organic synthesis. Among those applications the synthesis of optically active oxindoles having a quaternary asymmetric center has been considerably explored. Because the oxindole moiety serves as useful synthetic intermediate in the synthesis of numerous natural products. For example, (*E*)- α,β -unsaturated-2-iodoanilide undergoes cyclization in the presence of Pd₂(dba)₃-CHCl₃ and (*R*)-BINAP to give oxindoles with (*S*) or (*R*) configuration under cationic and neutral conditions, respectively. It is noteworthy that a dramatic switching in the direction of asymmetric induction has been observed between the two

conditions even though the same chiral ligand (*R*)-BINAP is employed. In these reactions, Ag₃PO₄ and PMP act as HI scavenger.

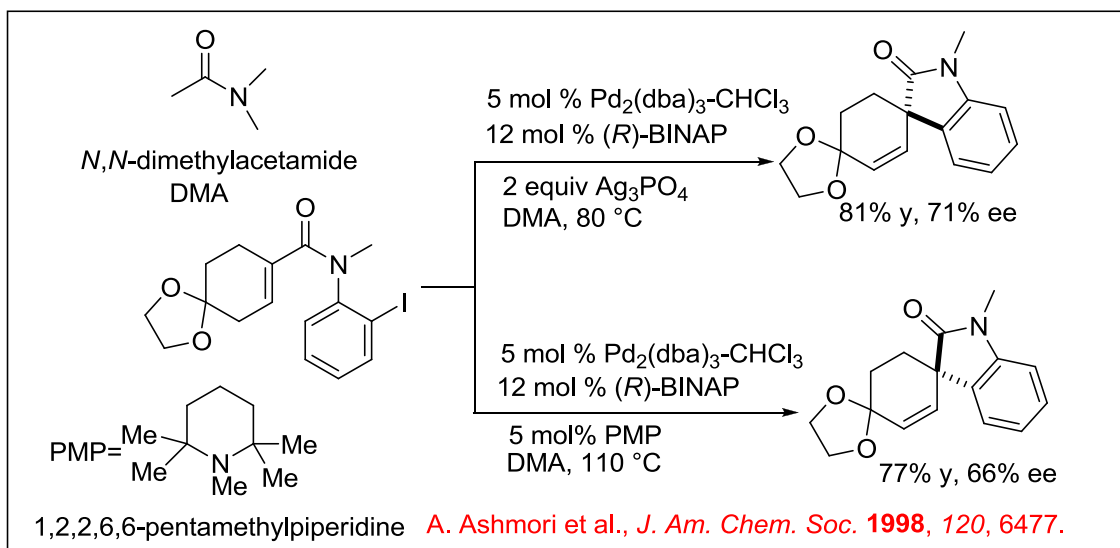

Scheme 10

The use of TADDOL-based monophosphoramidate has been demonstrated instead of BINAP in the reaction of intramolecular cyclization of cyclohexadienone derivatives (Scheme 11). This reaction can be performed in the absence of silver salt.

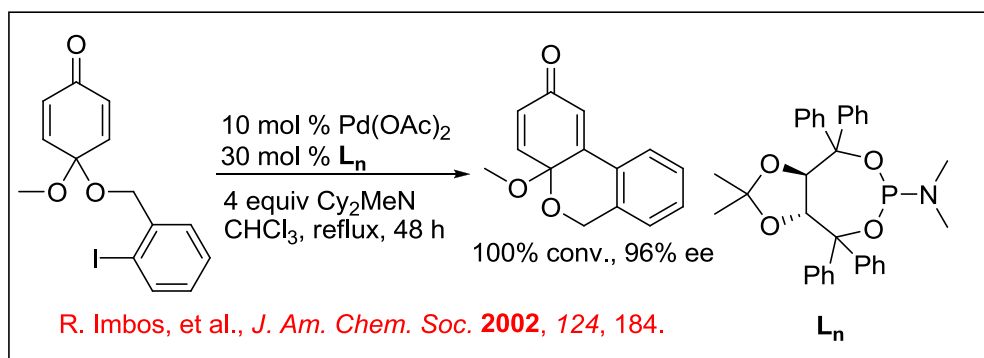

Scheme 11

Intermolecular Heck reaction is also well studied. For example, dihydrofuran reacts with phenyl triflate to give 2-phenyl-2,3-dihydrofuran along with small amount 2-phenyl-2,5-dihydrofuran in the presence of Pd-BINAP with excellent enantioselectivity (Scheme 12). A mechanism has been proposed to explain the high enantioselectivity of the major product and inversion configuration of the minor product (Scheme 13). It involves a kinetic resolution process that enhances the enantioselectivity of the major product.

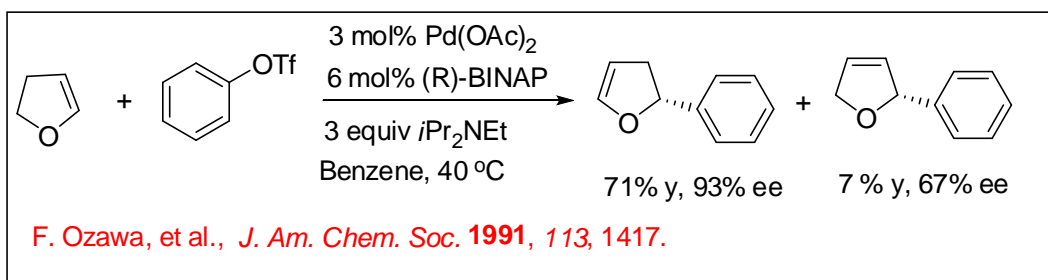

Scheme 12

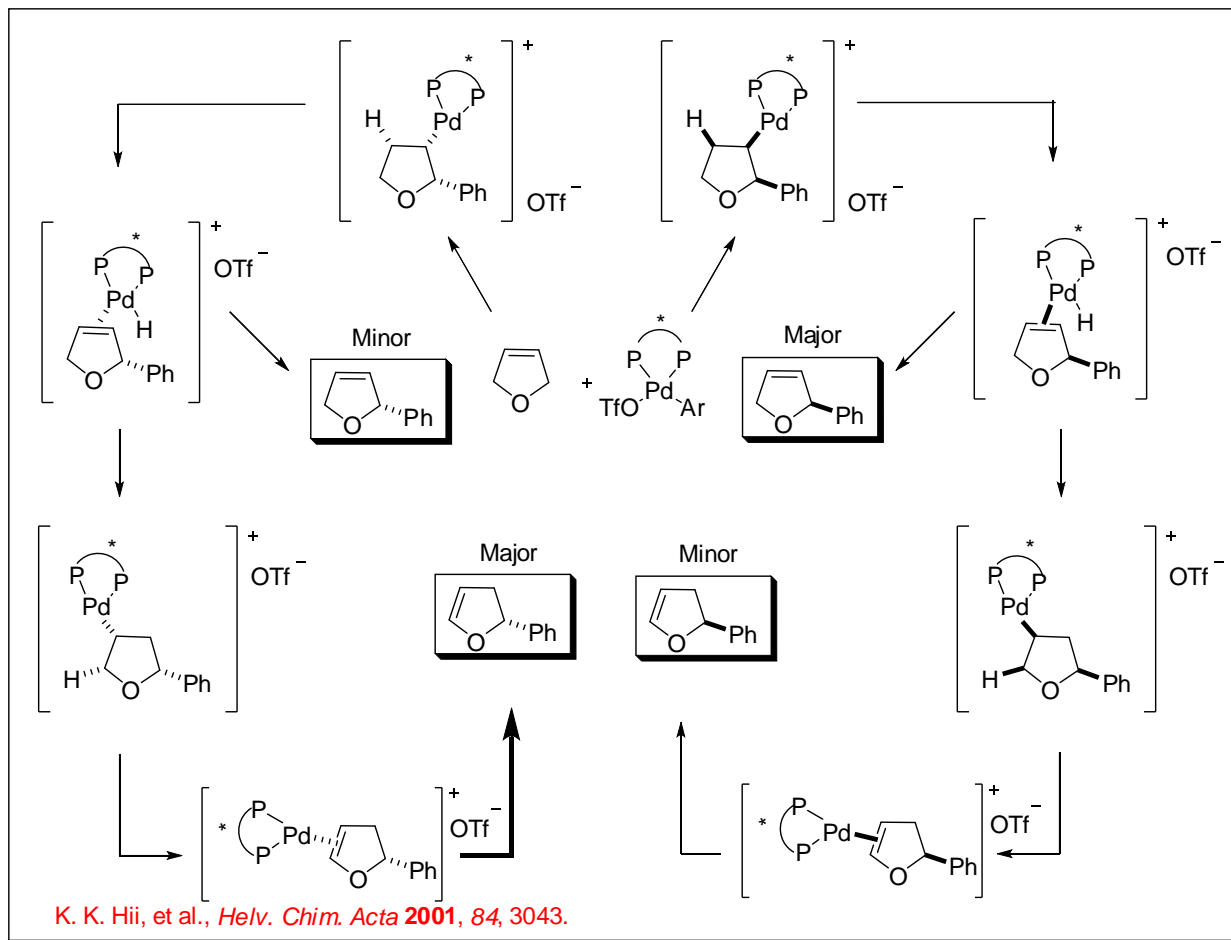

Scheme 13

Scheme 14 exemplifies the reactions of 2,3-dihydrofuran and 2,2-dimethyl-2,3-dihydrofuran with phenyl triflate, 2-carboethoxy cyclohexenyl triflate and cyclohexenyl triflate using palladium complexes with oxazoline based aminophosphine and (D-glucosamine)phosphiteoxazoline as the ligands. The reactions are effective affording the products with excellent enantioselectivity.

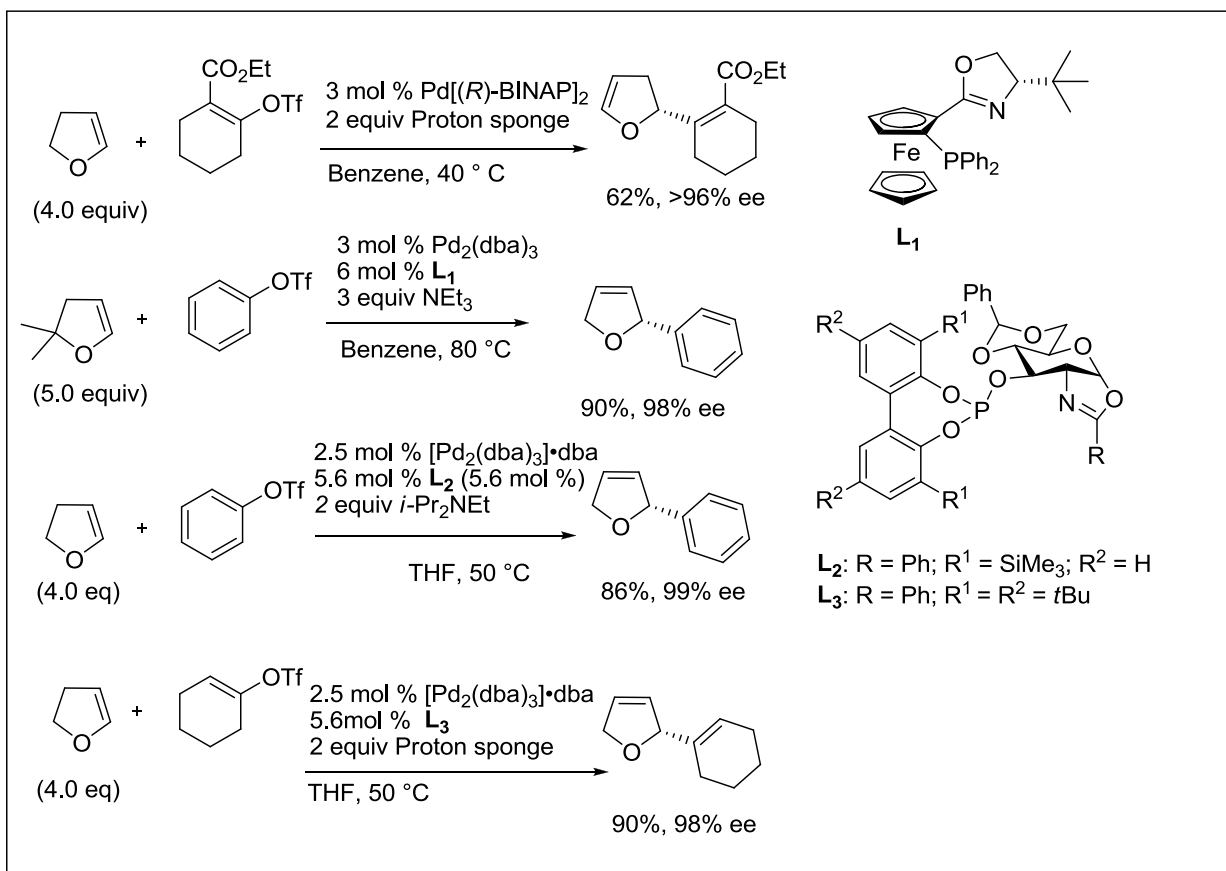

Scheme 14

Problems

- Give some examples of chiral Zr-catalyzed carbometallation reactions.
- Complete the following reactions.

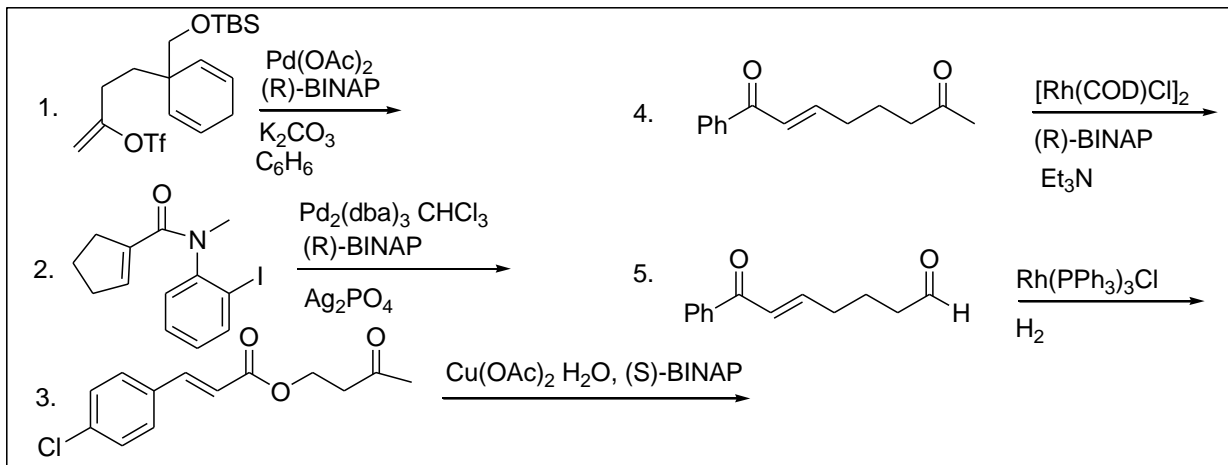

Reference/Text Book

5. I. Ojima, *Catalytic Asymmetric Synthesis*, 3rd ed., Wiley, New Jersey, 2010.
6. M. B. Smith, *Organic Synthesis*, 2nd edition, McGraw Hill, New Delhi, 2004.

Lecture 8

2.4 Metal-Catalyzed Asymmetric Conjugate Addition Reactions

Asymmetric conjugate addition is one of the powerful tools for the construction carbon-carbon and carbon-heteroatom bonds in organic synthesis. This reaction finds extensive applications for the construction enantioenriched carbon skeletons for the total synthesis of numerous biologically active compounds. Sometimes possible to construct multiple stereocentres in single synthetic operation. This lecture covers some examples for the recent developments in the conjugate addition of Grignard, organozinc, organolithium, organocopper and organoborane reagents with activated alkenes in the presence of chiral ligand or chiral catalysts.

2.4.1 Reactions of Grignard Reagents

The conjugated addition of Grignard reagents with electrophilically activated alkenes is well explored. Some of the chiral ligands developed for the conjugate addition reactions of Grignard reagents with α,β -unsaturated carbonyl compounds are shown in Scheme 1.

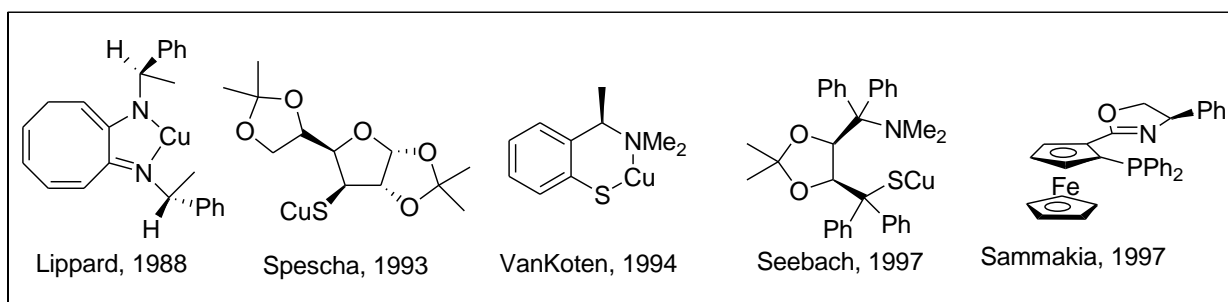

Scheme 1

One of the recent examples is the addition of alkyl magnesium bromide to α,β -unsaturated thioesters using Josiphos ligand **L-1** (Scheme 2). The reactions of a series of examples can be accomplished with up to 96% enantioselectivity.

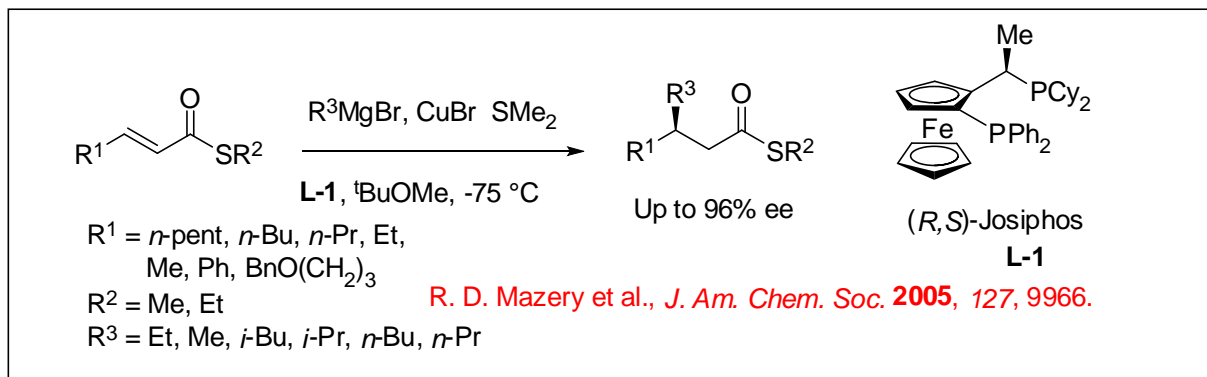

Compared to the 1,4-conjugate addition reaction, the reactions with extended Michael acceptors needs additional control of the regioselectivity. For example, using the *(R,S)*-reversed Josiphos ligand **L-2**, 1,6-asymmetric conjugate addition to $\alpha,\beta,\gamma,\delta$ -unsaturated esters has been developed (Scheme 3).

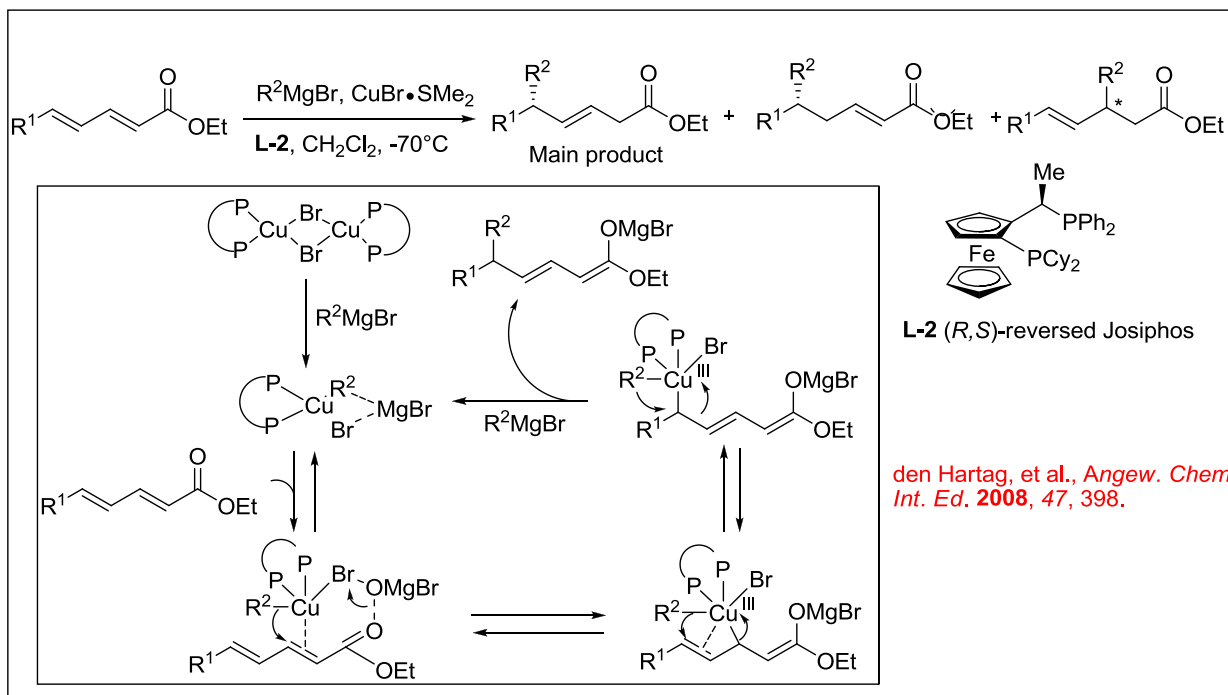

Besides the ferrocenyl ligands **L1-2**, taniaphos **L-3** with $\text{CuBr}\cdot\text{SMe}_2$ is also highly effective for the conjugate addition of allylic electrophiles with Grignard reagents (Scheme 4). In this reaction, aliphatic allylic bromides have been found to be excellent substrates.

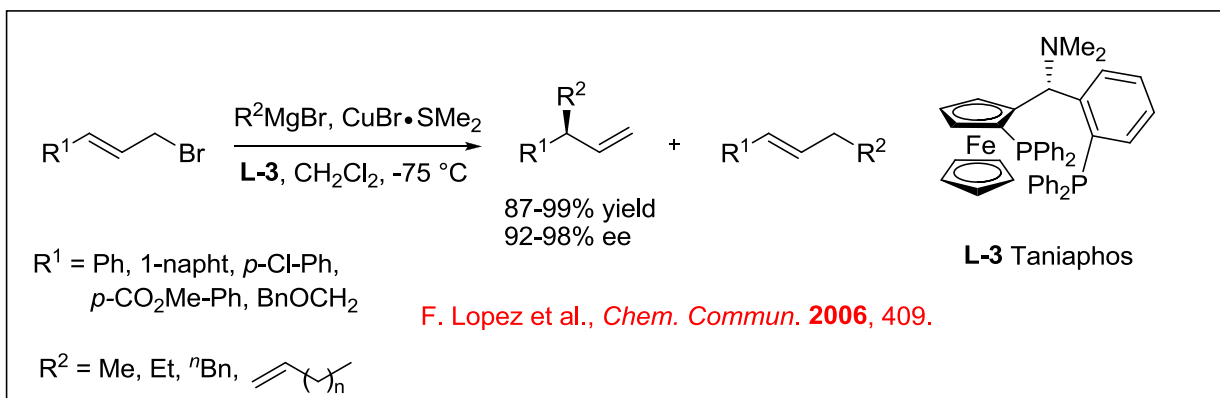

Scheme 4

2.4.2 Reactions of Organozinc Reagents

The asymmetric conjugate addition of dialkylzinc to prochiral α,β -unsaturated compounds is one of the powerful methods for carbon-carbon bond formation in organic synthesis. Much attention has been made on the development of new ligands for this reaction. Phosphoramidite ligand from BINOL **L-4** has been found to be effective for the conjugate addition to cyclic substrates with up to 98% ee (Scheme 5).

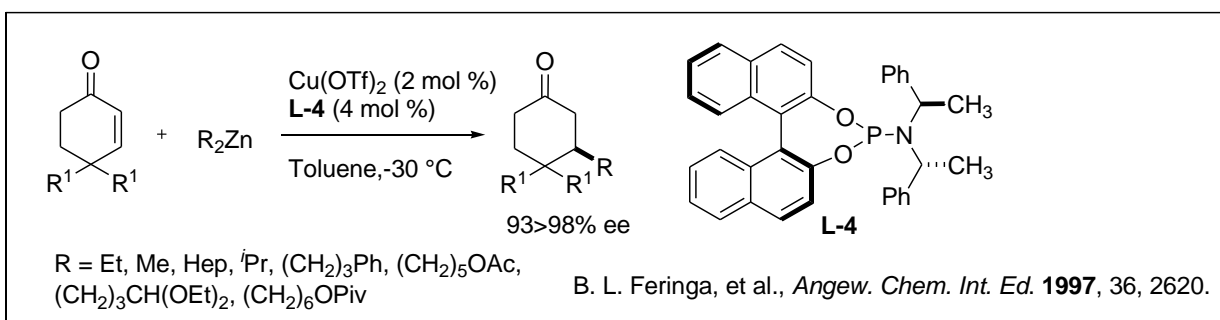

Scheme 5

Subsequently, copper(I)-catalyzed enantioselective addition of dialkylzinc to 3-nitroacrolein derivatives has been demonstrated using phosphoramidite ligands **L-5** and **L-6** with up to 98% ee (Scheme 6).

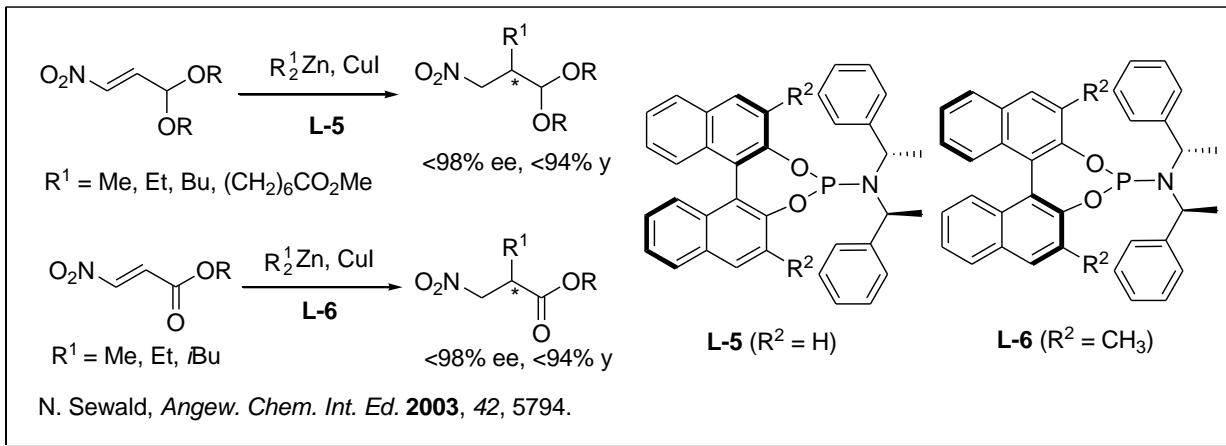

Scheme 6

Scheme 7 summarizes some of the peptide based ligands for the dialkylzinc addition to α,β -unsaturated compounds. For example, the copper-catalyzed conjugate addition of dialkylzinc reagents to acyclic aliphatic α,β -unsaturated ketones proceed in the presence of **L-9** with up to 94% ee, while the reaction using **L-10** gives up to 98% ee (Scheme 8).

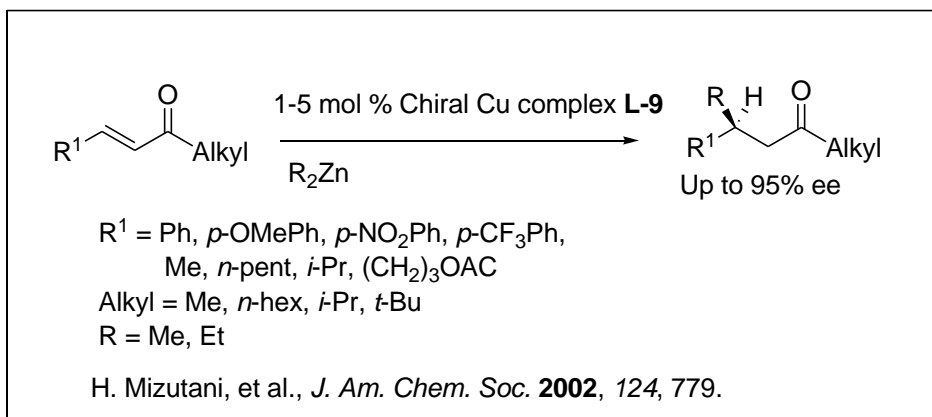
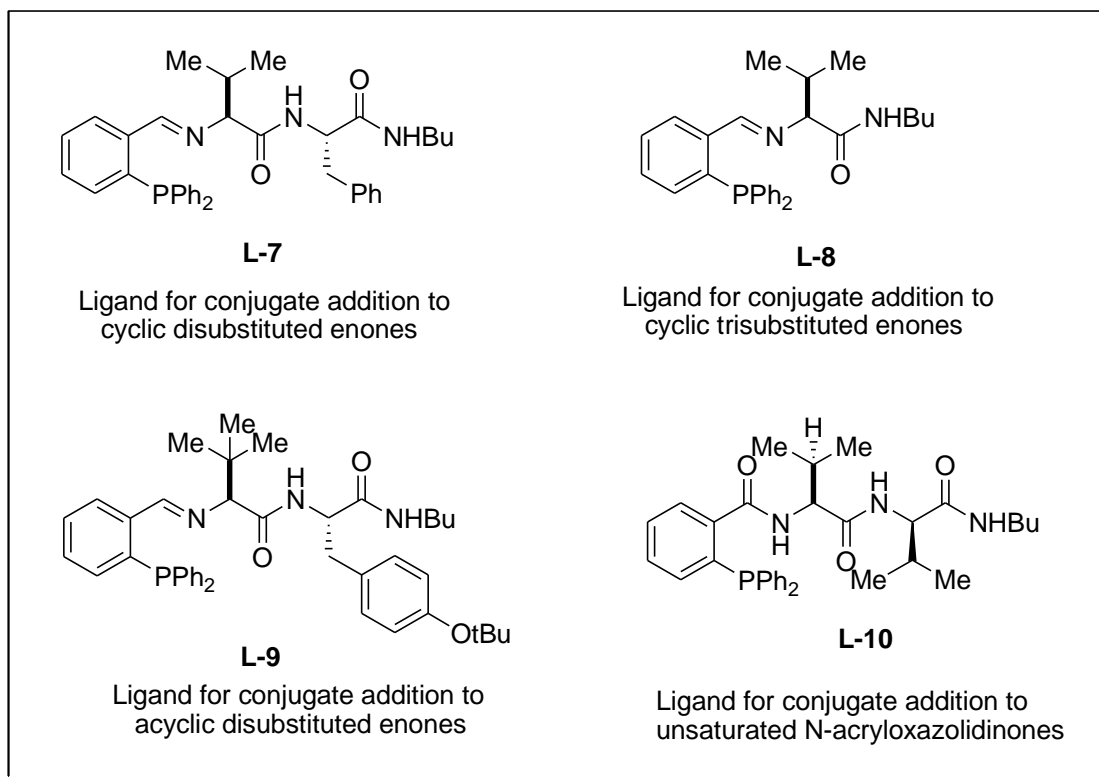

Scheme 7

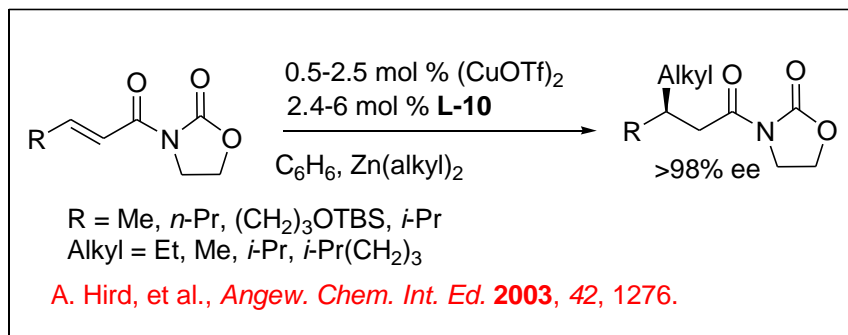

Scheme 8

Later, the chiral ligands **L-10** to **L-12** have been studied for the reactions of dialkylzinc reagents to heterocyclic enones such as furanones, pyranones and their derivatives (Scheme 9-10).

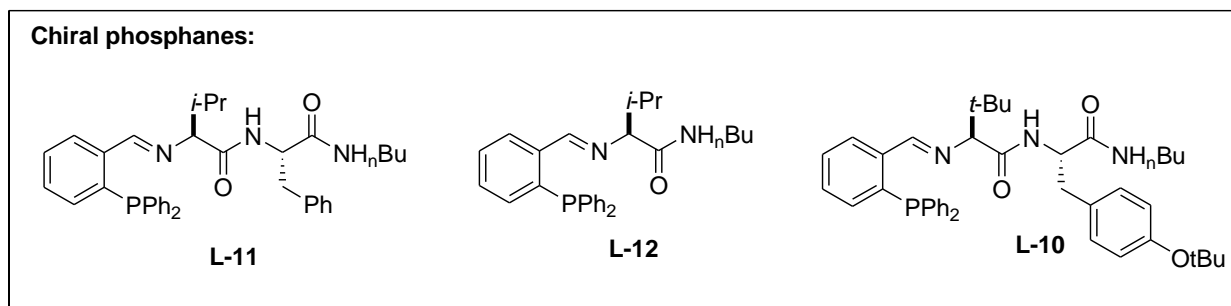

Scheme 9

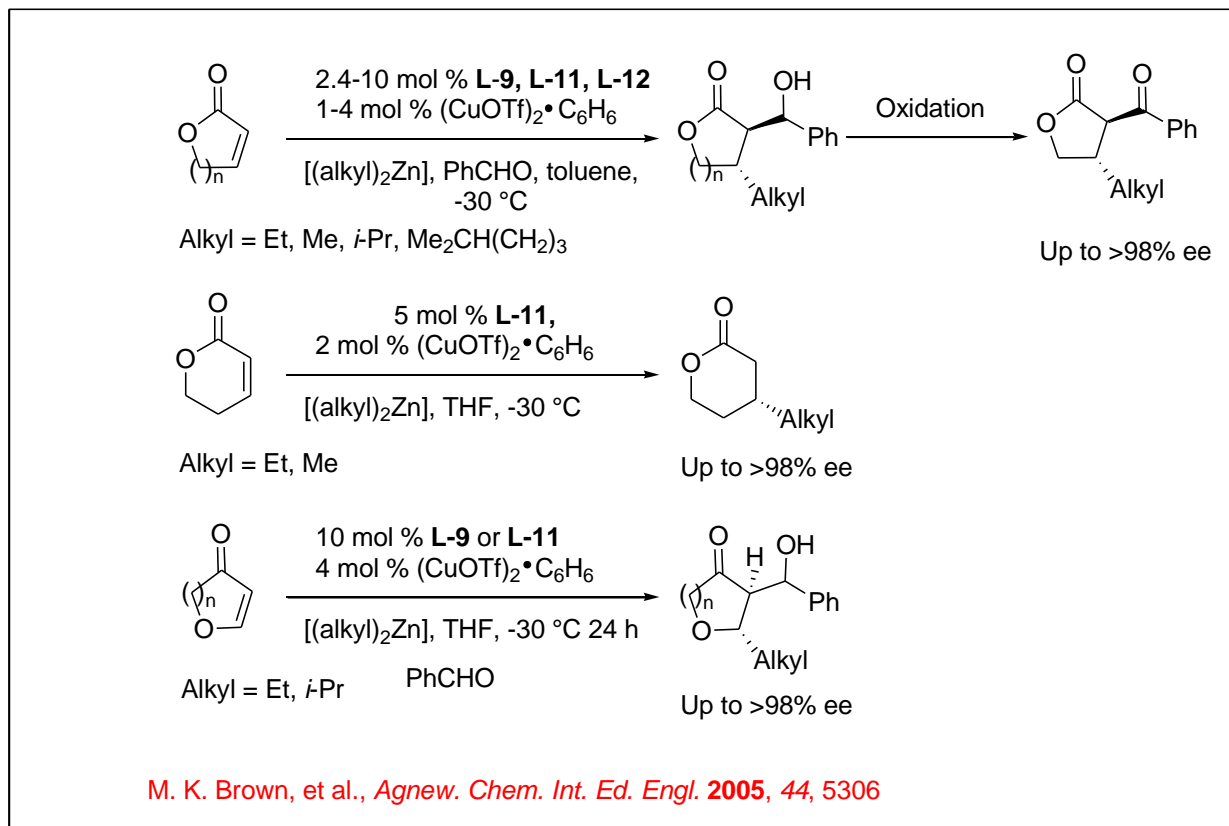

Scheme 10

2.4.3 Reactions of Organolithium Reagents

Organolithium reagents are highly reactive species and their conjugate addition reactions with α,β -unsaturated carbonyl compounds are of great interests. One of the recent examples is the reaction of configurationally stable organolithium to α,β -unsaturated cyclic carbonyl compounds using (-)-sparteine that can be performed with high enantioselectivity (Scheme 11).

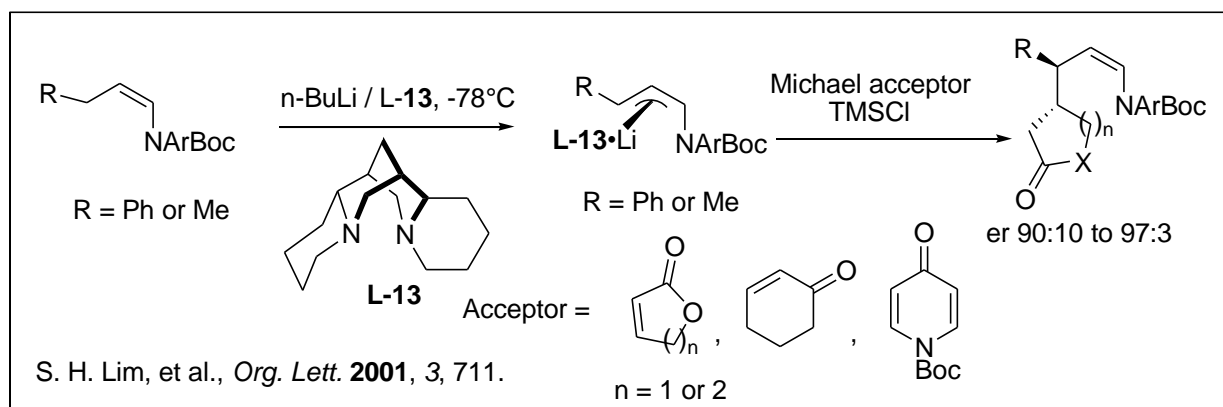

Scheme 11

2.4.4 Reactions of Organoboranes

The asymmetric conjugate addition of organoboranes using chiral rhodium phosphine complex is a successful process. For example, arylboronic and alkenylboronic acids undergo reaction with cyclic and acyclic α,β -unsaturated ketones in the presence of chiral rhodium complex bearing (*S*)-BINAP with high enantioselectivity (Scheme 12). The reaction proceeds *via* phenylrhodium, oxa- π -allylrhodium and hydroxorhodium intermediates (Scheme 13).

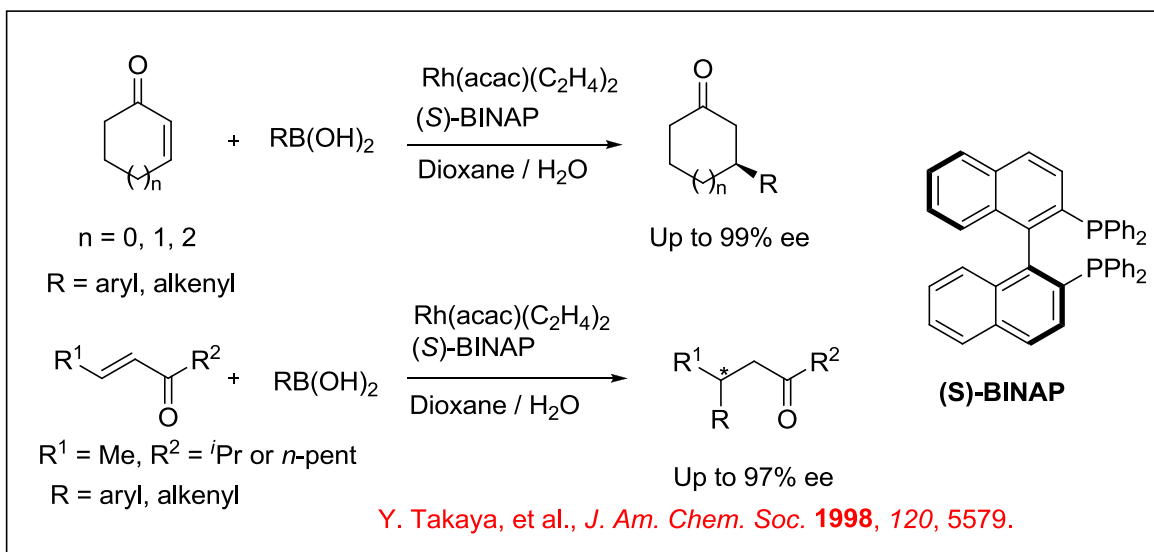

Scheme 12

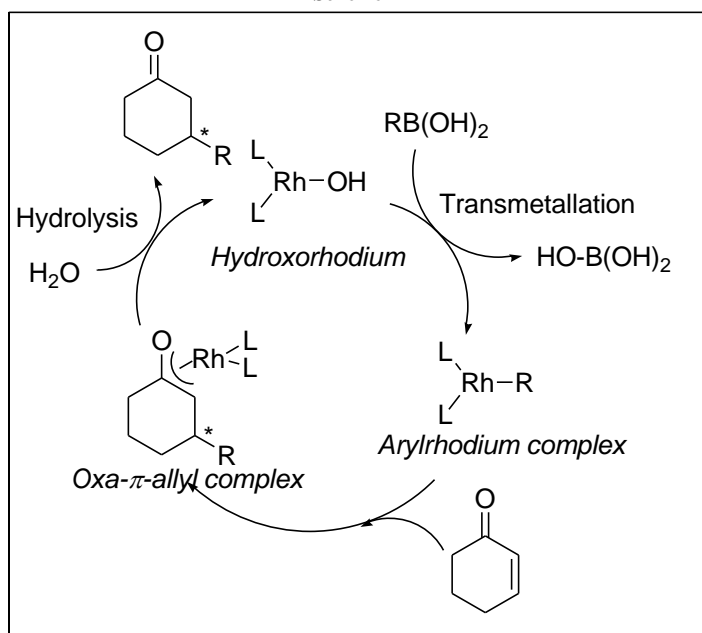

Scheme 13

Besides chiral biphosphines, chiral dienes and chiral phosphoramidite ligands are also effective for the rhodium catalyzed conjugate addition of organoboranes. For example, the rhodium catalyzed conjugate addition of boronic acids and potassium trifluoroborates to enones occurs with high enantioselectivity (Scheme 14).

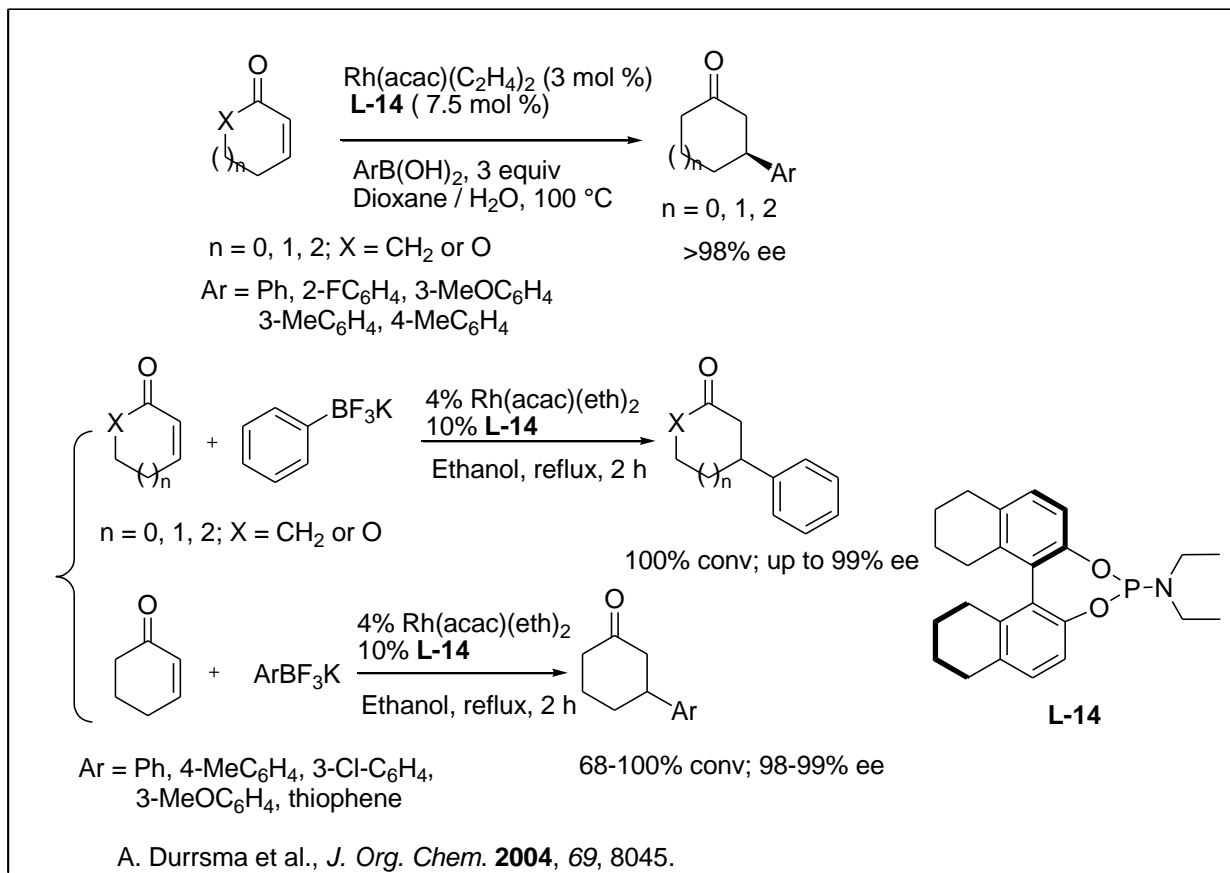

Scheme 14

Problems

C. Describe conjugate addition reactions using organocatalysis.

D. Complete the following reactions.

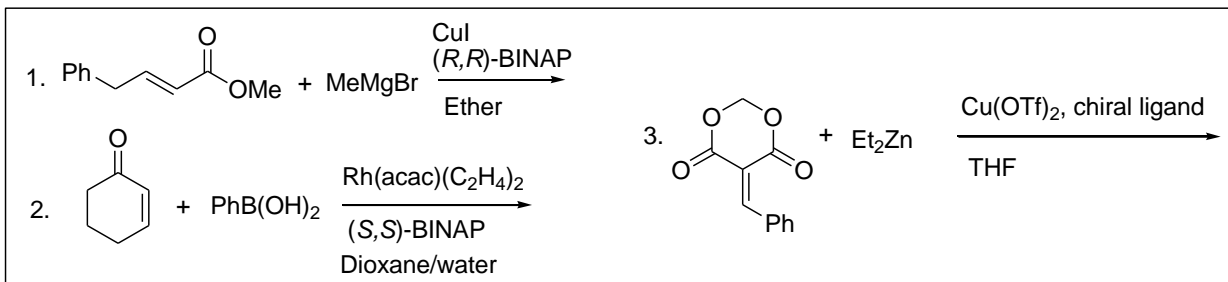

Reference/Text Book

7. I. Ojima, *Catalytic Asymmetric Synthesis*, 3rd ed., Wiley, New Jersey, 2010.

8. M. B. Smith, *Organic Synthesis*, 2nd edition, McGraw Hill, New Delhi, 2004.

Lecture 9

2.5 Allylic Substitution with Carbon Nucleophiles

The metal-catalyzed allylic substitution is one most of the important processes in organic synthesis. Scheme 1 represents the catalytic cycle of a transition metal based allylic substitution reaction. The reaction begins with the coordination of the low valent metal complex to the double bond of an allylic system. Subsequent oxidative addition by removal of the leaving group X gives a π -allyl complex as intermediate. The intermediate could be a neutral or cationic species, depending on the nature of the ligands and the counter ion X. The nucleophile typically adds to the terminal carbon with inversion of configuration rather than *via* the metal cation with retention (Scheme 1).

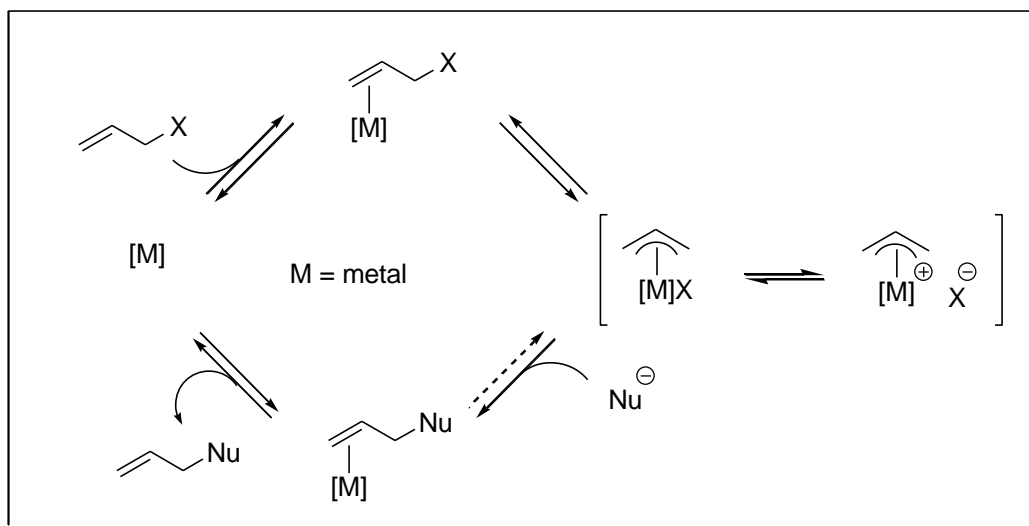

Scheme 1

2.5.1 Palladium-Catalyzed Reactions

The palladium catalyzed allylic substitution reaction is a very powerful process. This section covers some recent examples on the palladium catalyzed enantioselective allylic substitution with carbon nucleophiles. The use of azlactones as a soft stabilized pronucleophile is particularly important because they give rise to amino acids as products. Scheme 2 presents Trost's synthesis of spingofungins *via* alkylation of a geminal diacetate with an azlactone. The product is formed with good diastereo- and enantioselectivity.

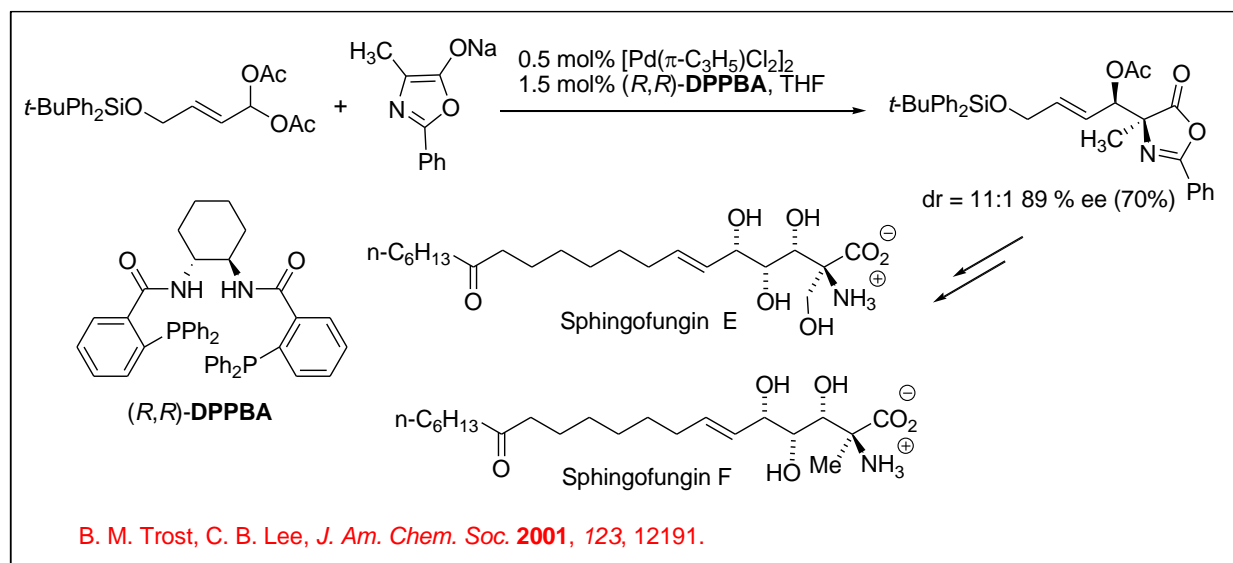

Scheme 2

Atom economical method to obtain $(\pi\text{-allyl})\text{Pd}$ intermediates from allenes by addition of hydrido-Pd complexes has been demonstrated (Scheme 3). This method affords the same products as that of the standard alkylation of allylic substrates. The pronucleophile are sufficiently acidic to produce HPdL_2 species (Scheme 4).

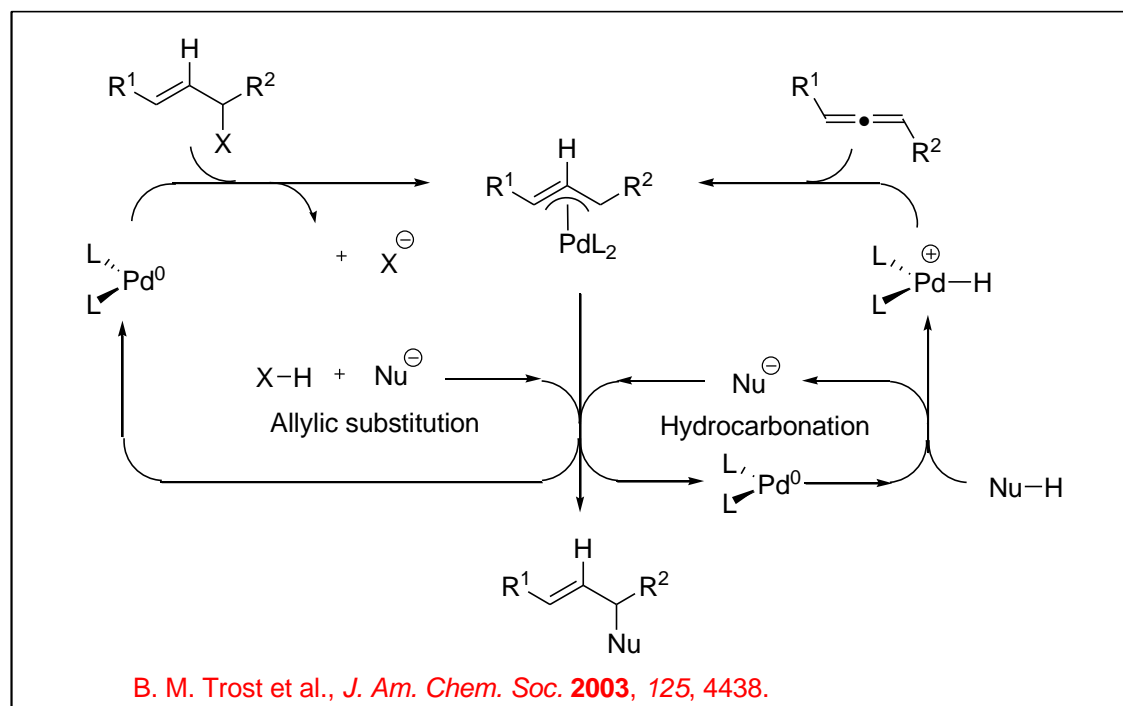

Scheme 3. Allylic alkylation and hydrocarbonylation

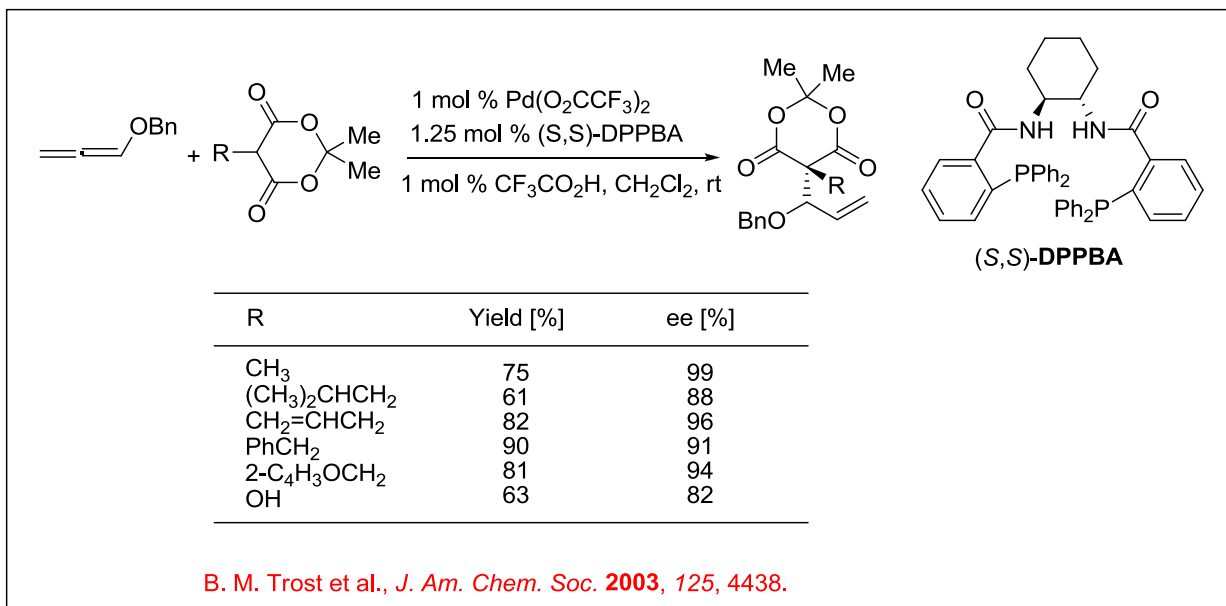

Scheme 4

The palladium catalyzed reaction of vinyl epoxide with nucleophiles provides branched products (Scheme 5). This is due to interaction of the nucleophile with an alkoxy or OH moiety produced by reaction with the Pd(0) species. For example, the reaction of isoprene monoepoxide with β -keto esters preferentially gives the branched alkylation products in the form of the hemiacetals (Scheme 6). The nature of the β -ketoester and optimization of the reaction conditions are crucial for the success of this process.

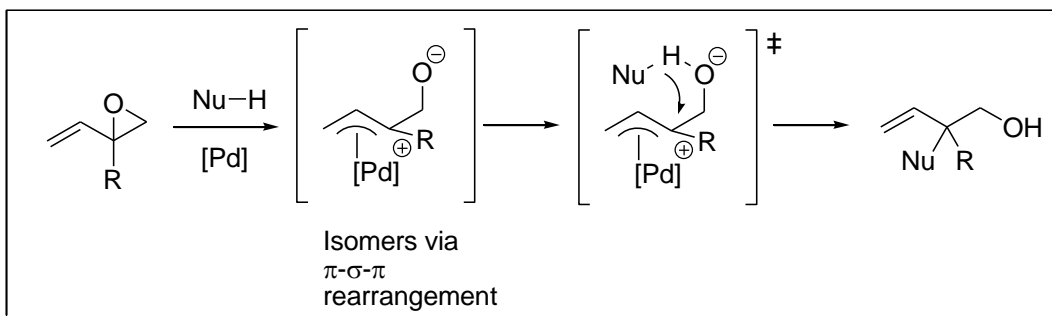

Scheme 5

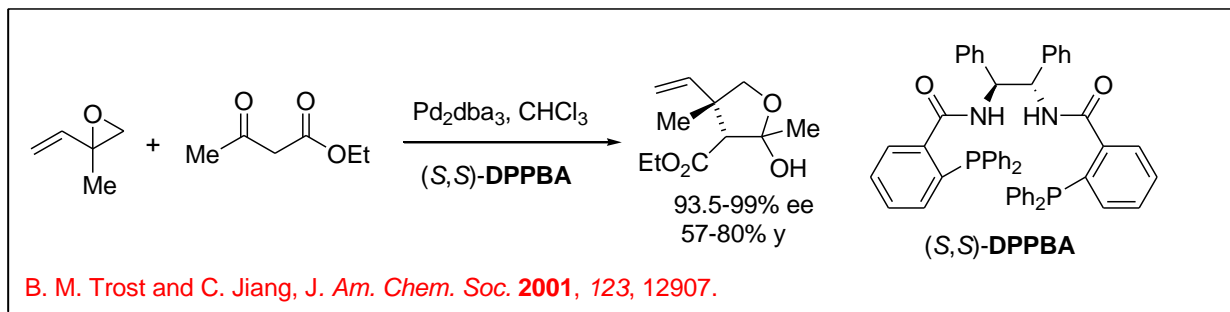

Scheme 6

Bimetallic system having $\text{Rh}(\text{acac})(\text{CO})_2$, $\text{Pd}(\text{Cp})(\pi\text{-C}_3\text{H}_5)$ and the ligand Anis Trap has been used for the allylic alkylation with α -cyanopropionic acid derivative as pronucleophile (Scheme 7). The control of the stereochemistry is believed to take place *via* the nucleophile with a chiral Rh complex coordinating to the cyano group.

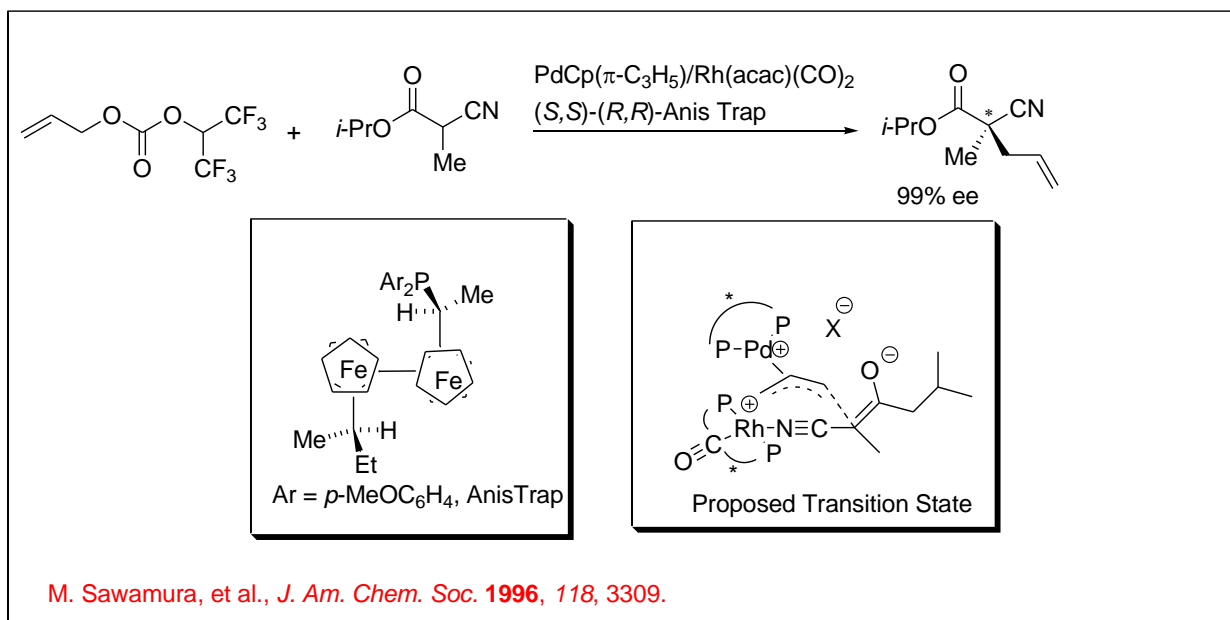

Scheme 7

Recently, allylic alkylation has been realized by enolate generated *in situ* by decarboxylation (Scheme 8). Both allylic β -keto carboxylates and allylic enol carbonates undergo facile decarboxylation after oxidative addition of a Pd(0) species (Scheme 9).

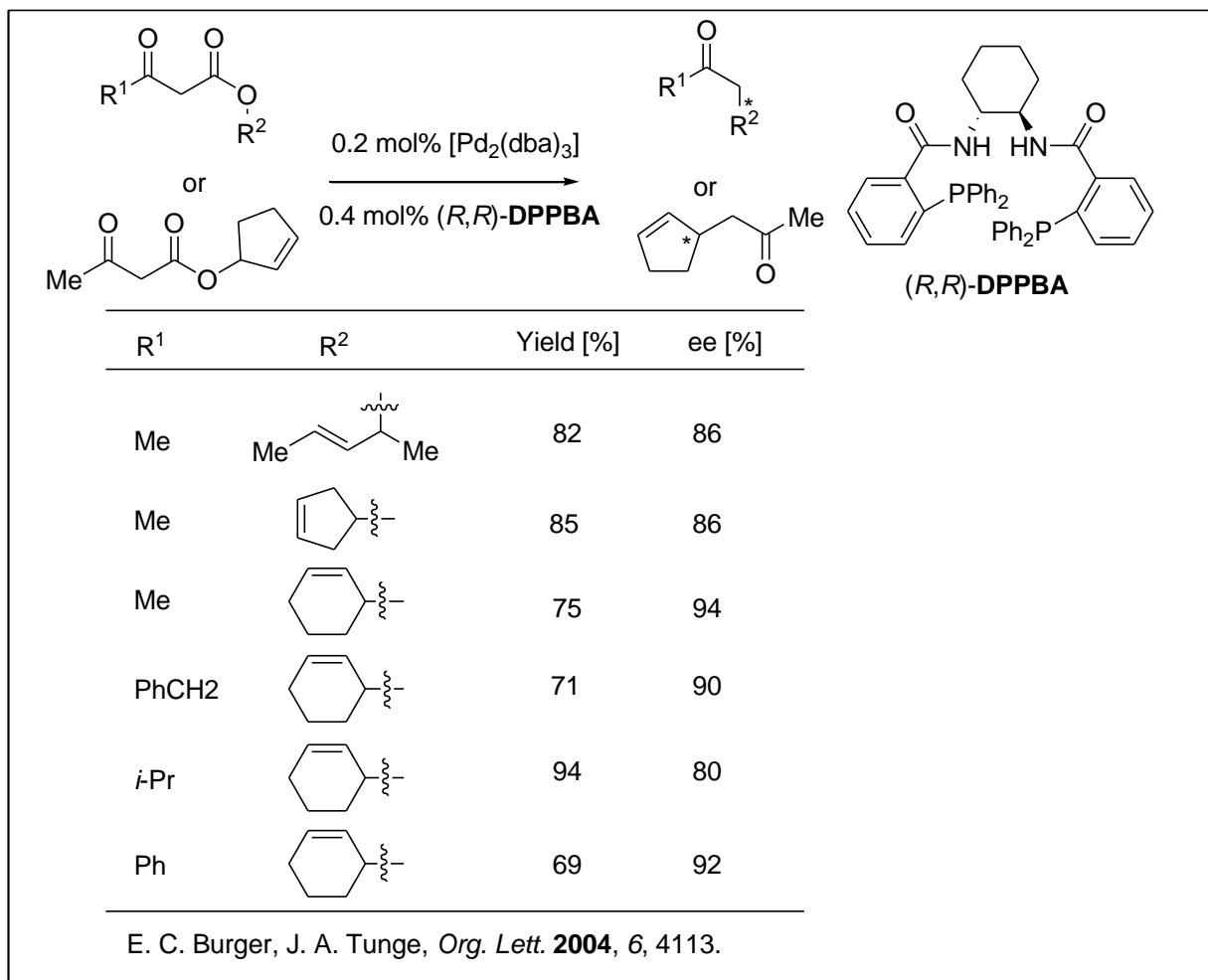

Scheme 8

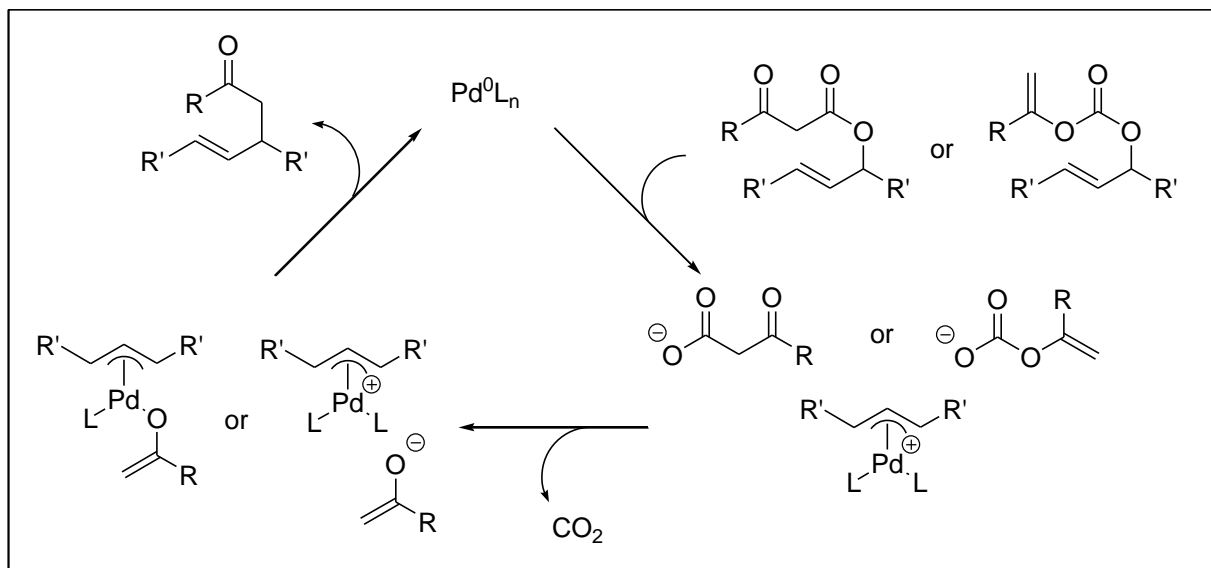

Scheme 9

2.5.2 Nickel-Catalyzed Reactions

In comparison to the palladium catalyzed reactions, the nickel based chemistry is less explored. In addition, the nickel based chemistry less popular with the reactions of soft nucleophiles and few examples only so far investigated. For example, the reaction of allylic acetates has been studied with soft nucleophiles such as dimethyl malonate using a wide range of phosphine ligands (Scheme 10). Linear allylic substrates give a mixture of regioisomers, whereas in cyclohexenyl acetate, the regioselectivity does not play any role affording the alkylated product with moderate enantioselectivity in the presence of chiral phosphine **L1**.

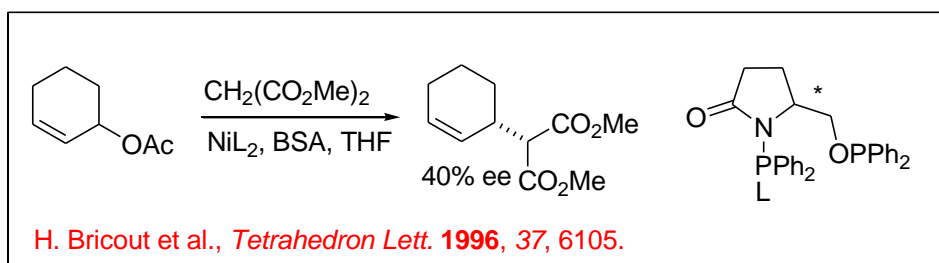

Scheme 10

However, the nickel based systems are very popular with the reactions of hard nucleophiles such as boronic acids, borates and Grignard reagents. For example, the reaction of 1,3-disubstituted allyl ethers with Grignard reagents

can be accomplished using nickel phosphine complex with good enantioselectivity (Scheme 11). The reaction of methyl ether gave better results compared to phenyl ethers. In this reaction, if the reaction is quenched before complete consumption of the starting material, a significant kinetic resolution is observed.

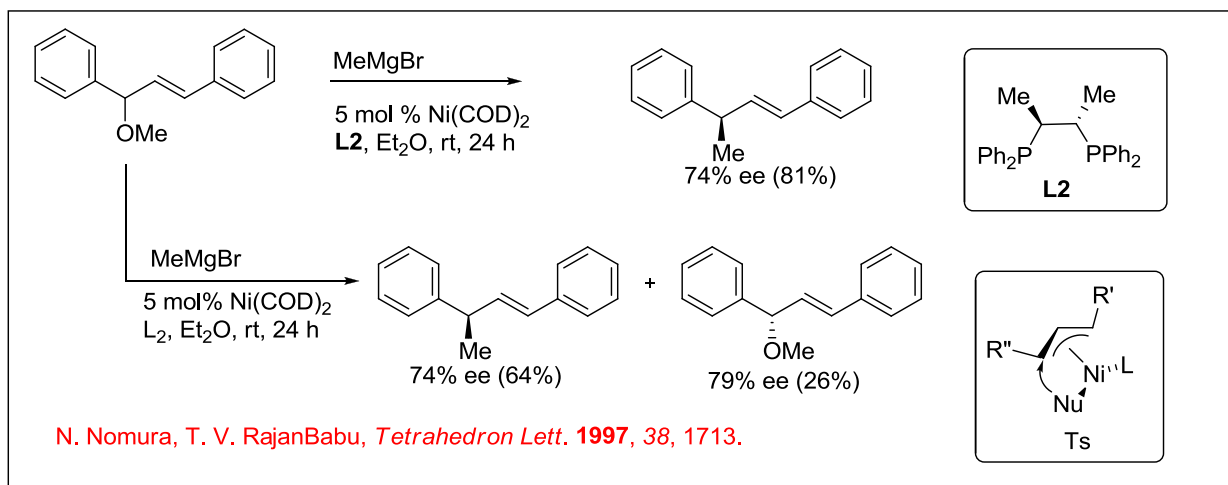

Scheme 11

2.5.3 Molybdenum-Catalyzed Reactions

Although the palladium catalyzed systems dominate in π -allyl chemistry, analogues Mo-catalyzed reactions have also emerged as powerful reactions in organic synthesis. The Mo-based reactions are the one first showed different regioselectivity compared to the palladium catalyzed systems. Scheme 12 illustrates the mechanism for the asymmetric Mo-catalyzed allylic alkylation.

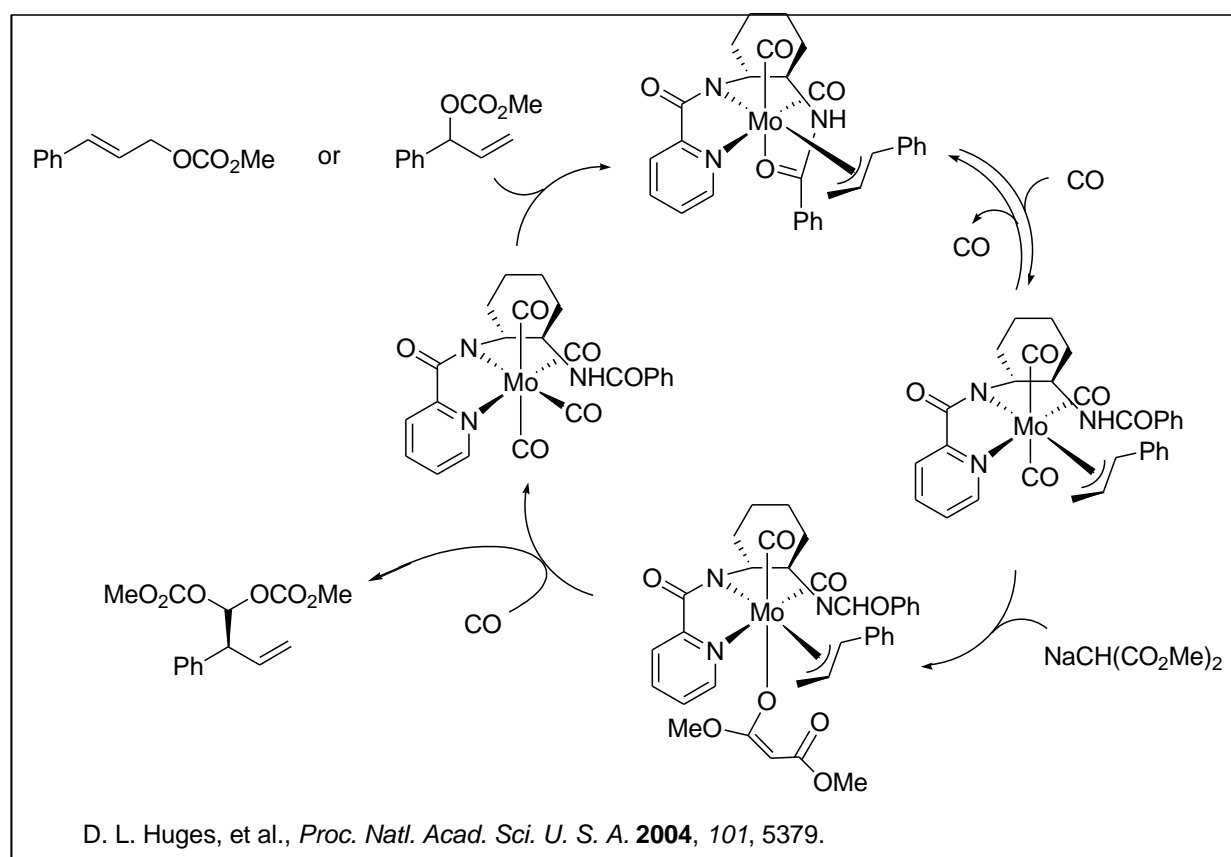

Scheme 12

2.5.4 Copper-Catalyzed Reactions

In case of the nonsymmetrical allylic substrates, the palladium catalyzed allylic alkylation reactions show poor regioselectivity. In this context, the copper based chemistry is an interesting alternative and lots of efforts have been made on this topic during last years. The copper based systems tolerate a wide range of hard and nonstabilized nucleophiles. Scheme 13 presents the regioselectivity in copper-catalyzed allylation reactions. In unsymmetrical substrates, nucleophile may attack directly at the leaving group (S_N2) or at the allylic

position (S_N2') under migration of the double bond depending on the reaction parameters as well as the substrate and nucleophile.

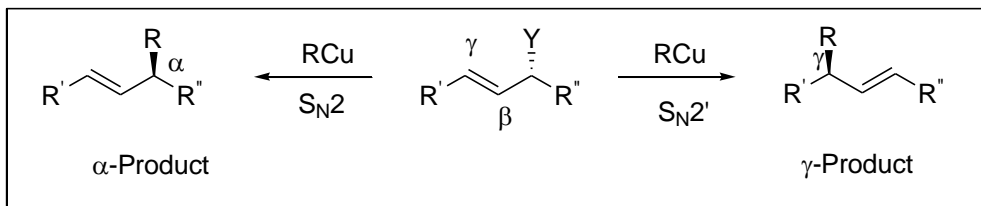

Scheme 13

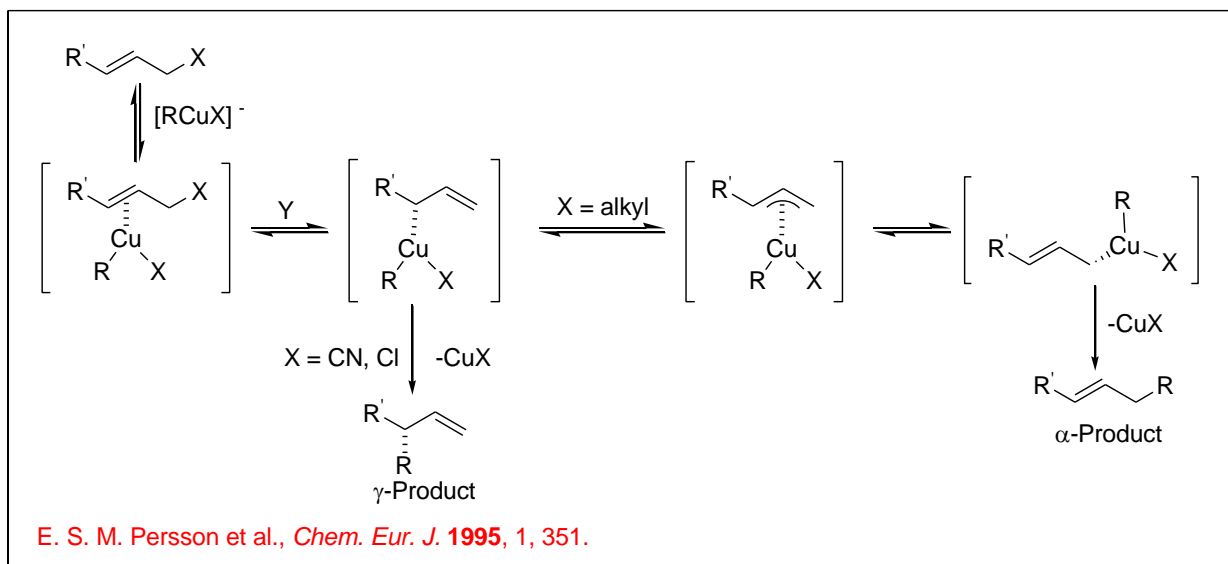

Scheme 14

The observed results suggest that the regioselectivity and stereoselectivity are established at different stages (Scheme 14). For example, the reaction of chiral carbamates with achiral copper reagent gives S_N2' product with excellent enantioselectivity (Scheme 15).

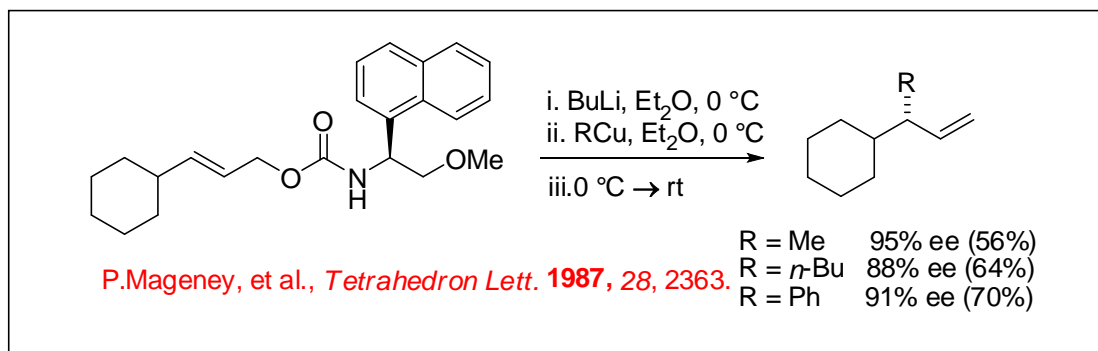

Scheme 15

Problems

E. Predict the major product for the following reactions.

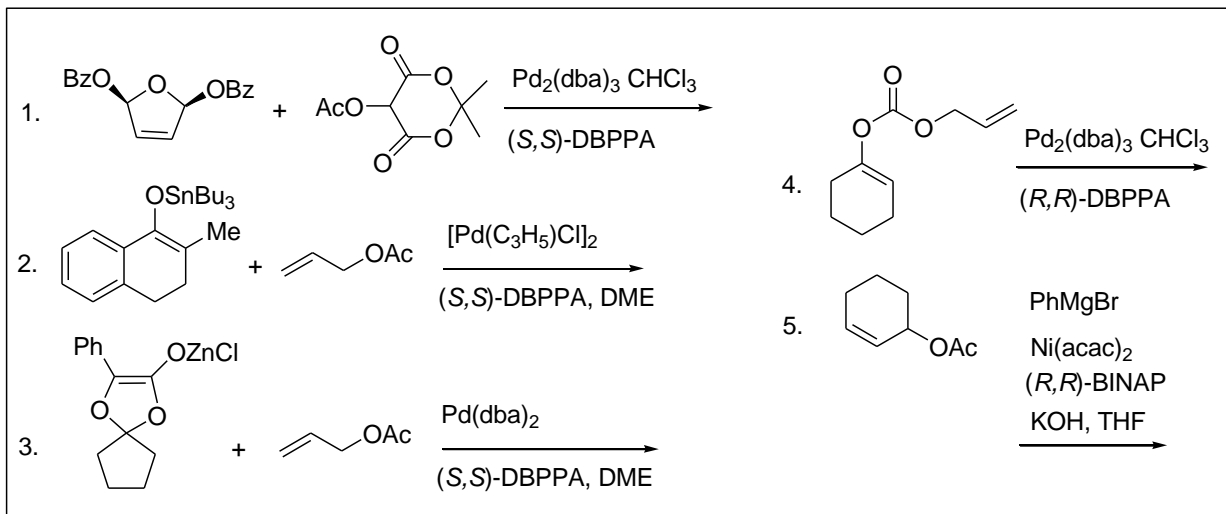

F. Describe the chiral Fe, Ru, Ir and Rh-catalyzed asymmetric allylic alkylation reactions.

Reference/Text Book

9. I. Ojima, *Catalytic Asymmetric Synthesis*, 3rd ed., Wiley, New Jersey, 2010.
10. M. B. Smith, *Organic Synthesis*, 2nd edition, McGraw Hill, New Delhi, 2004.

Lecture 10

Functionalization of C-H bonds constitutes an attractive approach for the direct synthesis of complex organic molecules such as pharmaceuticals, natural products, and other industrially relevant targets. Thus, much effort has been devoted to achieve practical, catalytic and selective methods for the C-H functionalization. Scheme 1 presents the two major directions evolved for the C-H functionalization process: (i) direct C-H activation involving oxidative addition to the C-H bond onto an active metal center, and (ii) insertion of transition metal-coordinated carbenes or nitrenes into the C-H bond to give functionalized products.

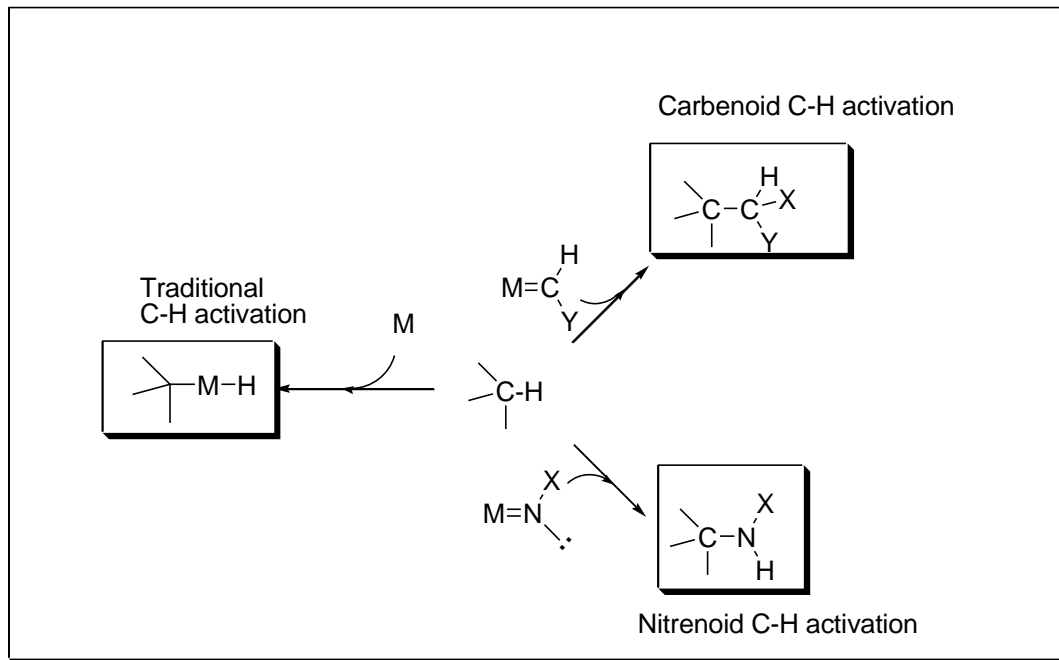

Scheme 1. Modes of C-H Activation

3.1 Reactions with Metal Carbenoid

Metal carbenes generally produced from diazo compound by metal-catalyzed nitrogen extrusion. Alternative carbene precursors include iodonium, sulfonium, sulfoxonium, thiophenium and phosphonium ylides, but their synthetic application is less explored. The general mechanism for the generation of carbene via dirhodium complexes is shown in Scheme 2. In the presence of suitable metal complex, the diazo compound can coordinate

reversibly and undergo rate limiting extrusion of nitrogen to give reactive metal carbenoid intermediate. The latter will react with a suitable trapping agent present in the reaction mixture.

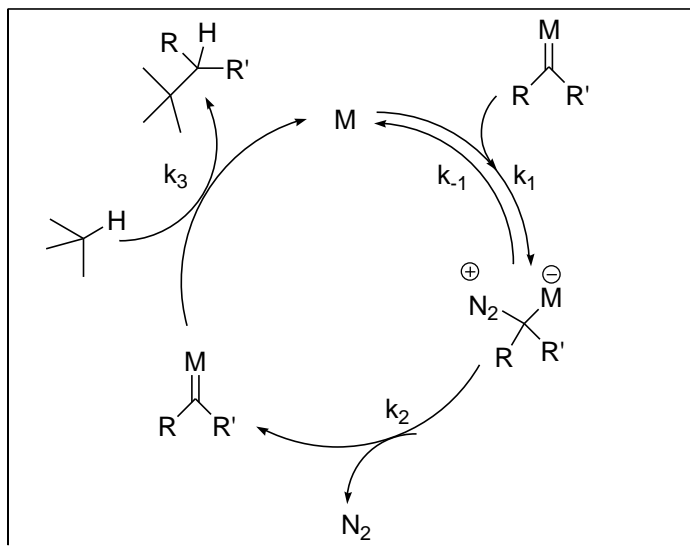

Scheme 2. Carbenoid C-H Insertion

For example, chiral dirhodium complexes catalyze the intramolecular C-H insertion of α -diazo- β -ketoester to give the intermediate for the total synthesis of the marine secosteroid (-)-astrogorgiadiol (Scheme 3). Up to 58% de is observed with moderate yield of 38% employing $\text{Rh}_2(\text{S-biTISP})_2$ as the catalyst. The reaction using $\text{Rh}_2(\text{S-PTPA})_2$ afforded excellent yield but with lower diastereoselectivity.

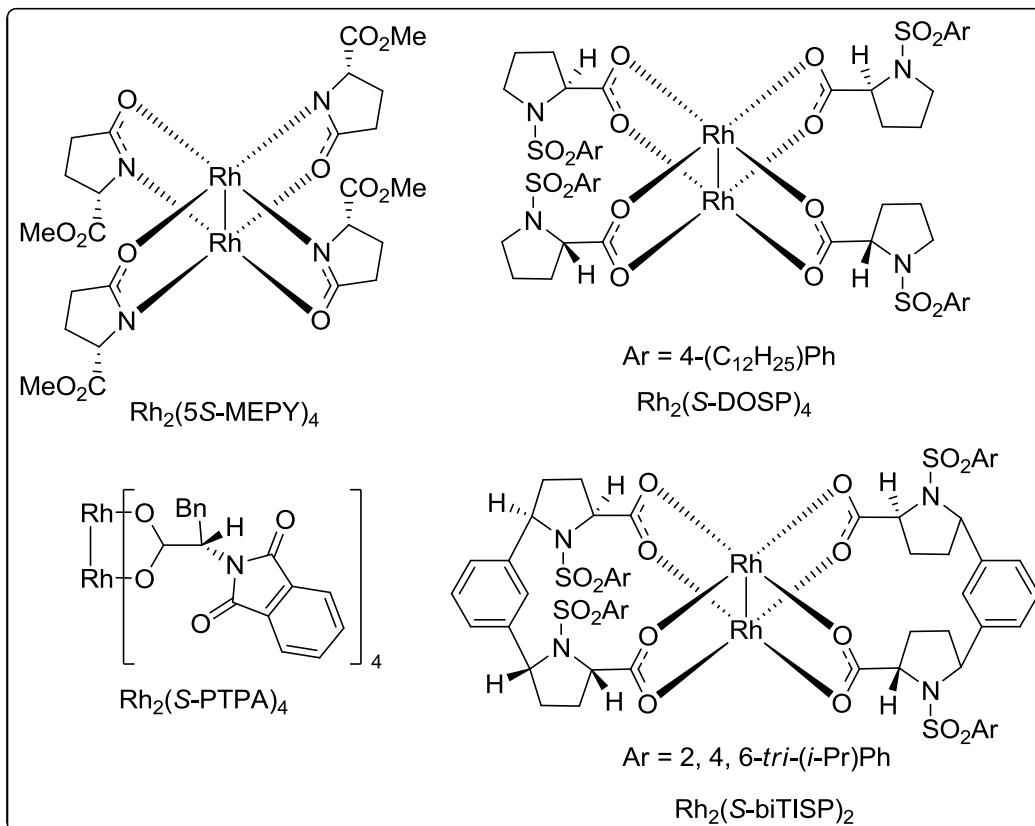

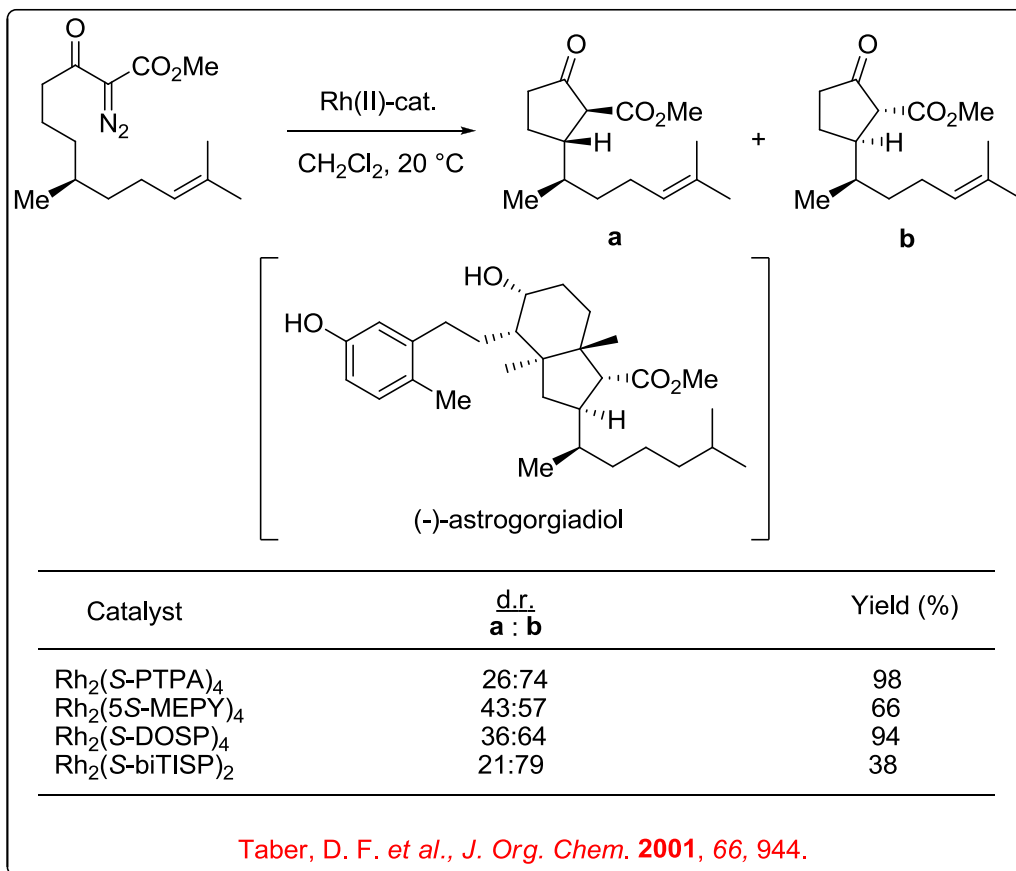

Scheme 3. Synthetic Studies toward (-)-Astrogorgiadiol

ortho-Metallated arylphosphine dirhodium(II) complexes are found to be effective catalysts for intramolecular C-H insertions of certain diazoketones (Scheme 4). One of the examples is the use of dirhodium complex **1** for the reaction of chloro-substituted system to afford cyclopentanone in 74% ee and 87% yield. This system works well with the aryl portion having electron withdrawing group.

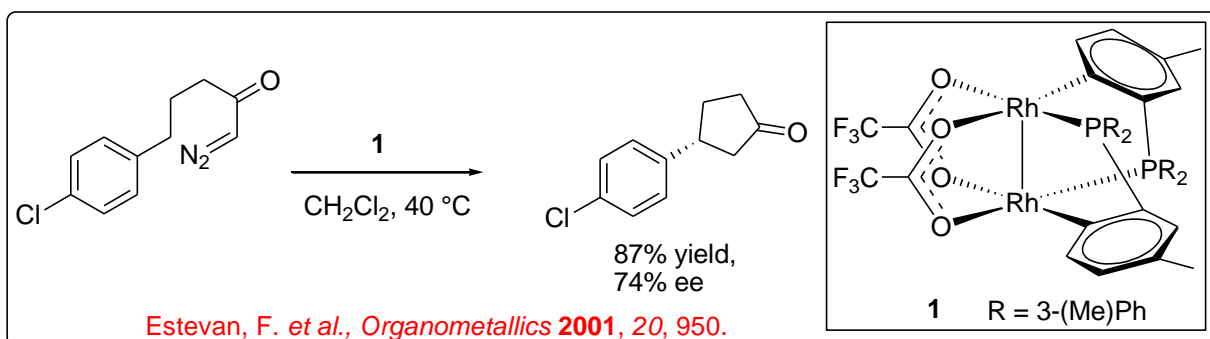

Scheme 4

Scheme 5 illustrates an example for the stereocontrolled formation of quaternary stereocenter using chiral $\text{Rh}_2(\text{S-PTTL})_4$ catalyzed carbenoid C-H insertion process.

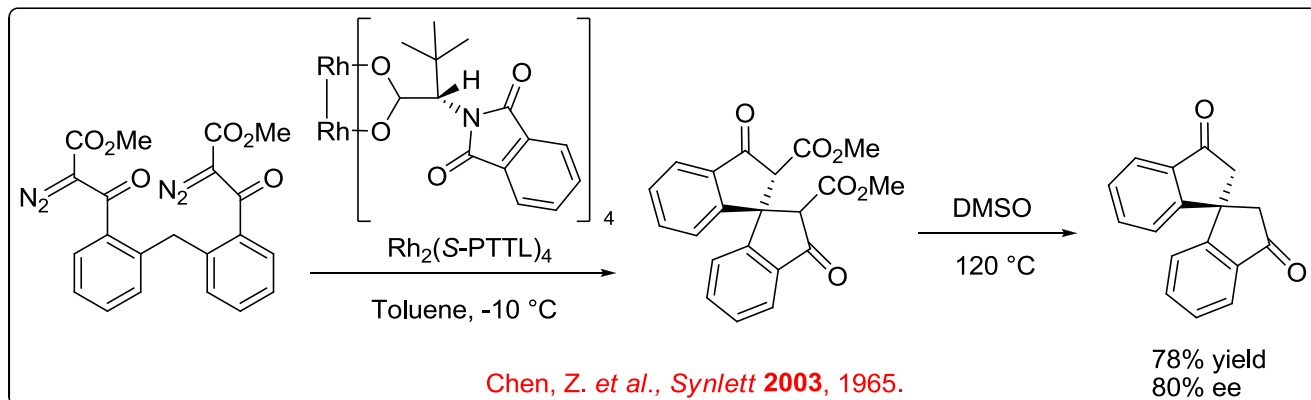

Scheme 5

The above catalytic system is also effective for the desymmetrization of aryl-substituted diazo ketoesters (Scheme 6). This reaction proceeds via electrophilic aromatic substitution and turnover numbers of up to 98000 have been achieved.

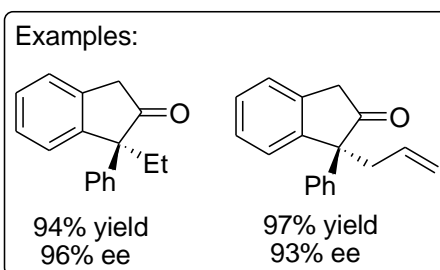
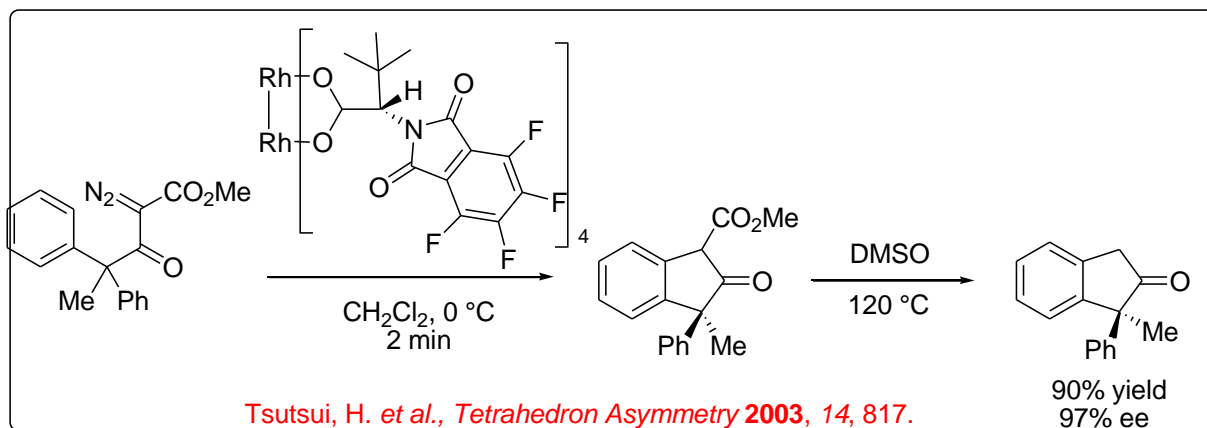

Scheme 6

Furthermore, the construction of *cis*-cyclopentanones from diazoester can be achieved via exclusive insertion (Scheme 7). In addition, the construction of disubstituted *cis*-indane can be accomplished with 85% yield and 92% ee (Scheme 8). These examples illustrate that the choice of the reaction conditions and catalysts for carbenoid transformation are crucial for selectivity.

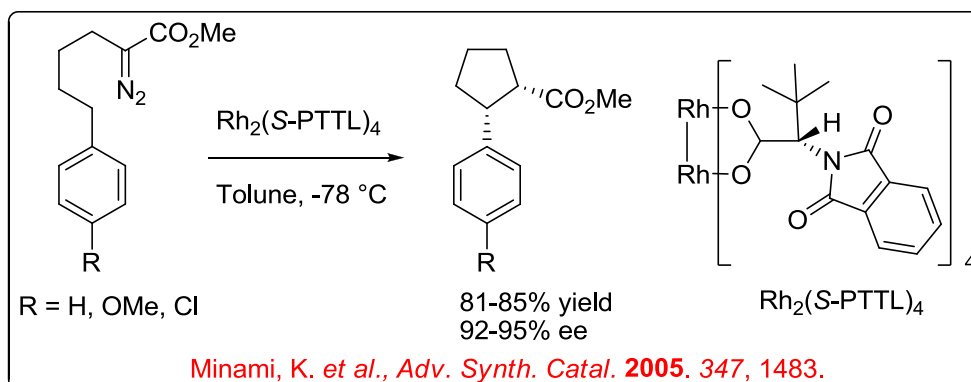

Scheme 7

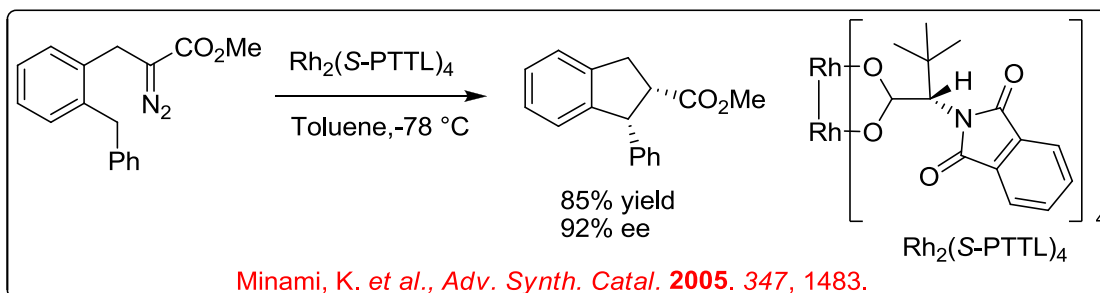

Scheme 8

Problems

Complete the following reactions.

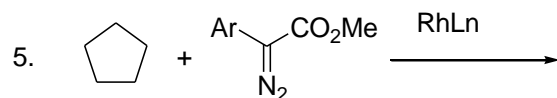
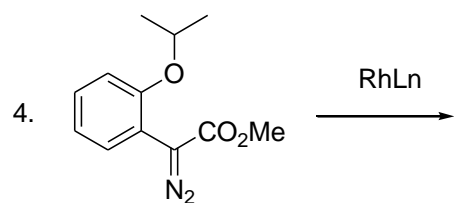
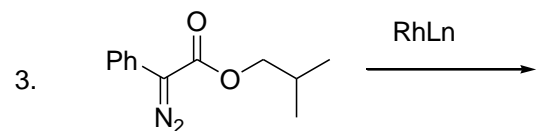
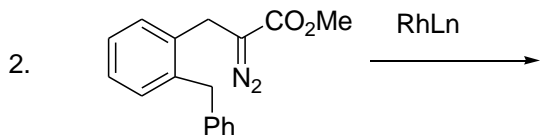
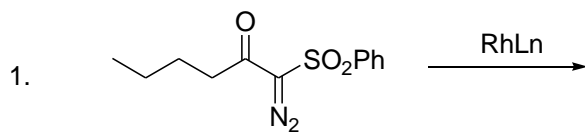

Reference/Text Book

11. I. Ojima, *Catalytic Asymmetric Synthesis*, 3rd ed., Wiley, New Jersey, 2010.
12. M. B. Smith, *Organic Synthesis*, 2nd edition, McGraw Hill, New Delhi, 2004.